

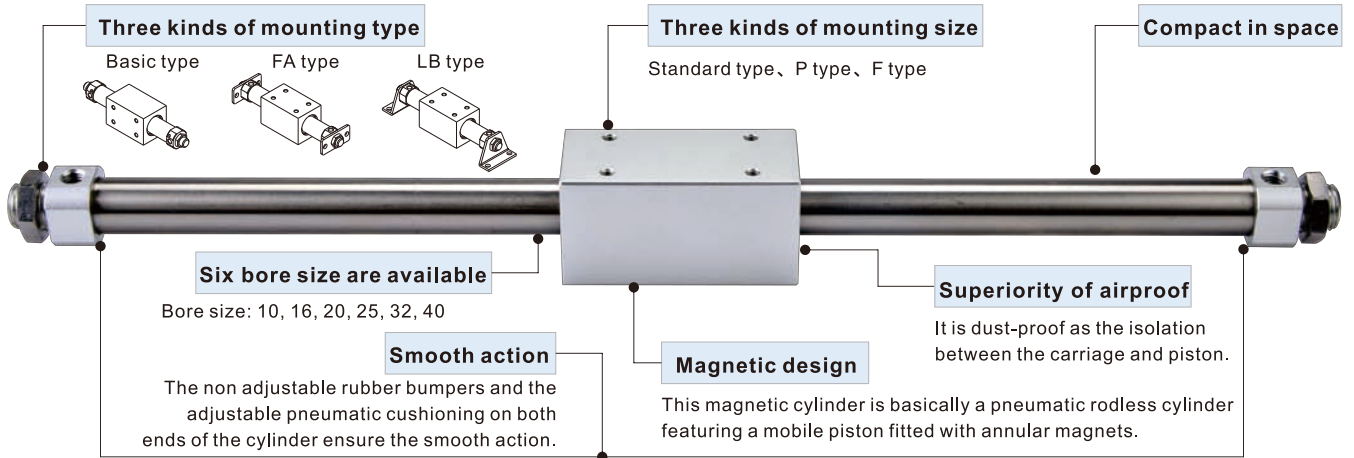

Rodless magnetic cylinder—RMS Series

Compendium of RMS Series



Installation and application

- The maxi load to move must be less than the theoretical holding force.
- How to mount load:
 - Horizontal mounting: the permissible radial load must be lower than the figures in the chart below.

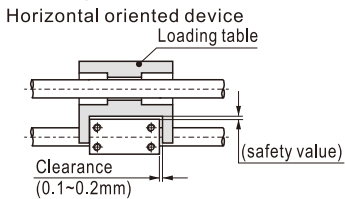

Bore size	10	16	20	25	32	40
Max. Loading table weight(kg)	0.4	1.0	1.1	1.2	1.5	2.0

[Note] If Max. load be larger than the value of above table, please conform with our company.

- In horizontal movement, please choose proper bore size based on Force-Velocity chart
- Find required pushing force
 - Find moving velocity
 - Choose proper spec based on force-Velocity chart

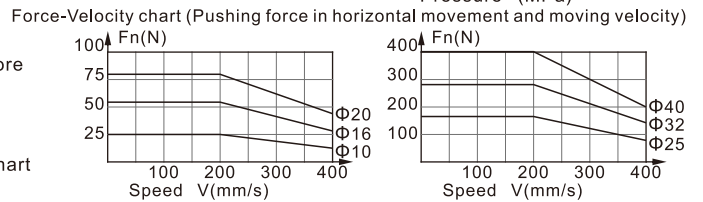
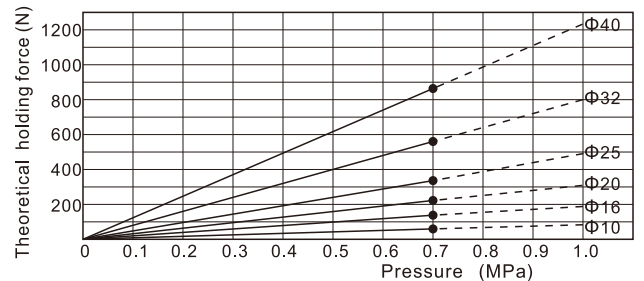

- Vertical mounting: The load guiding method should adopt rolling support (linear guide rail, etc.); if the sliding support is used, the sliding resistance will increase due to the load mass and the torque generated by the load, resulting in poor operation.

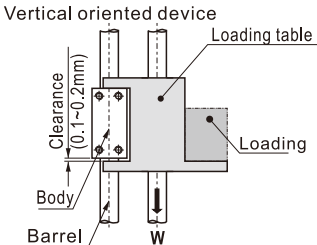

Bore size	Max. Load weight(Load+Loading table)(kg)
10	2.2
16	5.6
20	8.8
25	15
32	24
40	37

[Note] If pressure be larger than the max. pressure, magnetic core might disengage.

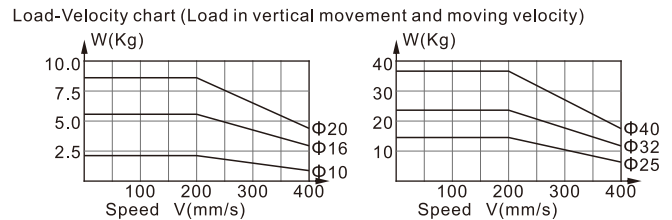

3. Middle-stop:

- When using stopper mechanism to fulfill middle-stop application, working pressure of cylinder cannot exceeds figures stated in the table on the right. Once working pressure exceeds these figures, energy cannot be absorbed when hitting happens on external stopper and it may cause discouple. Shock absorber is recommended in stopper design. When adjusting the mechanism, observe that if hitting process is done smoothly and there is no bounce happened.
- In designing middle-stop application for pneumatic system, allowable kinetic energy must be within figures shown in the table on the right. (Moving speed needs to be smaller than max velocity)

Note : When kinetic energy exceeds allowable figures, discouple will happen, which means body and piston inside the barrel will separate from each other, please be careful when design.

- Dirty substances in the pipe must be eliminated before cylinder is connected with pipeline to prevent the entrance of impurities into the cylinder.
- The medium used by cylinder shall be filtered to 40 μ m or below.
- If the cylinder is dismantled and stored for a long time, pay attention to conduct anti-rust treatment to the surface. Anti-dust jam cap shall be added in air inlet and outlet ports ;
- Non-magnetically conductive materials are recommended for workpieces fitted to the cylinder, otherwise the lifetime may be halved if magnetically conductive materials are used.

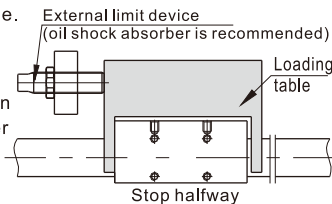

Bore size	Maximum allowable working pressure for middle-stop
10	0.55MPa
16	0.55MPa
20	0.55MPa
25	0.55MPa
32	0.55MPa
40	0.55MPa

Bore size	Allowable kinetic energy for middle-stop application in pneumatic system(ES)(J)
10	0.03
16	0.13
20	0.24
25	0.45
32	0.88
40	1.53



Rodless magnetic cylinder

RMS Series



Specification

Series name	RMS Series		RMS, RMSF Series				RMSP Series			
Bore size(mm)	10		16	20	25	32	40	16	20	32
Acting type	Double acting									
Fluid	Air(to be filtered by 40μm filter element)									
Operating pressure	0.2~0.7MPa (29~100psi)(2.0~7bar)		0.15~0.7MPa(22~100psi)(1.5~7bar) [Note2]							
Proof pressure	1.2MPa(175psi)(12.0bar)									
Temperature °C	-20~70									
Speed range mm/s	50~400									
Stroke tolerance mm	0~250 ^{+1.0} ₀		251~1000 ^{+1.5} ₀		1001~ ^{+2.0} ₀					
Cushion type	Bumper		Variable cushion+Fixed cushion							
Port size [Note1]	M5×0.8		1/8"			1/4"	M5×0.8	1/8"		
Safe holding force N	55		140	220	345	560	880	140	220	560

[Note1] PT thread, G thread and NPT thread are available.

[Note 2] when stopping in the middle, Operating pressure shall not exceed 0.55MPa, and buffer shall be provided when stopping at both ends.

Stroke

Bore size (mm)	Standard stroke (mm)	Max.std stroke
10	50 100 150 200 250 300	1000
16	50 100 150 200 250 300 350 400 450 500	1500
20	50 100 150 200 250 300 350 400 450 500 600 700 750 800 900 1000	2000
25	50 100 150 200 250 300 350 400 450 500 600 700 750 800 900 1000	2500
32	50 100 150 200 250 300 350 400 450 500 600 700 750 800 900 1000	3000
40	50 100 150 200 250 300 350 400 450 500 600 700 750 800 900 1000	3000

[Note] Consult us for non-standard stroke.

Product feature

1. This magnetic cylinder is basically a pneumatic rodless cylinder featuring a mobile piston fitted with annular magnets. The mobile carriage is also equipped with magnets to provide magnetic coupling (carriage/piston). The carriage slide freely along the main tube.
2. It is dust-proof as the isolation between the carriage and piston.
3. It is compact in space.
4. The non adjustable rubber bumpers and the adjustable pneumatic cushioning on both ends of the cylinder ensure the smooth action.

Symbol

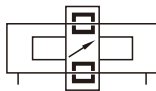

Ordering code

RMS □ 20 ×200 □ □

① ② ③ ④ ⑤ ⑥

① Model	② Version	③ Bore size	④ Stroke	⑤ Mounting type [Note1]	⑥ Thread type [Note2]
RMS: Rodless magnetic cylinder	Blank: basic version	10 16 20 25 32 40	Refer to stroke table for details	Blank: non bracket LB: LB type FA: FA type	Blank: PT G: G T: NPT
	P: P size version	16 20 32			
	F: F size version	16 20 25 32 40			

[Note1] RMSF40 series do not have FA mounting accessories.

[Note2] Blank on thread code means metric M thread. There is only metric thread for Φ10/Φ16. if G or NPT thread is needed, please consult

Inner structure and material of major parts

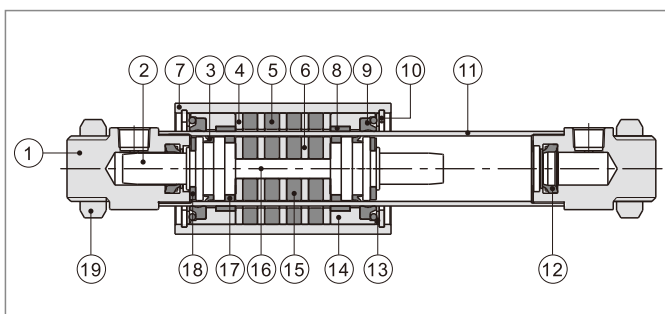

NO.	Item	Material	NO.	Item	Material
1	End cap	Aluminum alloy	11	Barrel	Stainless steel
2	Piston	Aluminum alloy	12	Cushion O-ring	TPU
3	Piston seal	TPU	13	Washer	Stainless steel
4	Magnet washer	Carbon steel	14	Cover	Aluminum alloy
5	Magnet	Rare-earth material	15	Magnet	Rare-earth material
6	Magnet washer	Carbon steel	16	Connecting rod	Stainless steel
7	Body	Aluminum alloy	17	Wear ring	Wear resistant material
8	Wear ring	Wear resistant material	18	Bumper	NBR
9	Scraping dust ring	Plastics	19	Nut	Stainless steel
10	C Clip	Spring steel			

Rodless magnetic cylinder

RMS Series

Dimensions

RMS RMS-P

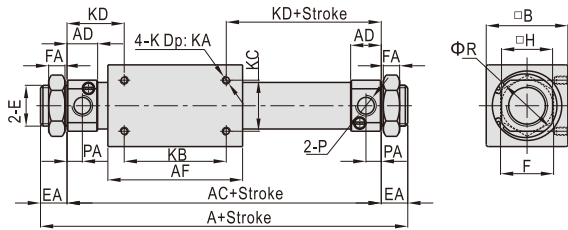

RMS-F

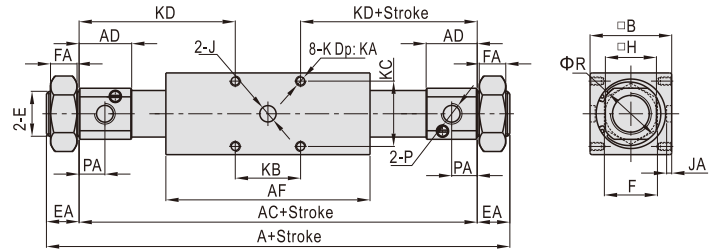

Model\Item	A	AC	AD	AF	B	E	EA	F	FA	H	J	JA	K	KA	KB	KC	KD	P	PA	R
RMS10	91	73	9.5	48	25	M10×1.0	9	14	4	15	-	-	M3×0.5	4	30	16	21.5	M5×0.8	5	17
RMS16	103	83	10	57	35	M10×1.0	10	14	4	20	-	-	M4×0.7	5	35	19	24	M5×0.8	5.5	22
RMSP16	112	92	14.5	57		M10×1.0	10	14	4		-	-	M4×0.7	7	34	25	29		7.5	
RMSF16	205	181	34	80	40	M16×1.5	12	23	8	25	8	3	M5×0.8	7.5	26	26	77.5	1/8"	20	29
RMS20	132	106	15	66		M20×1.5	13	26	8		-	-	M4×0.7	5.5	50	25	28		7.5	
RMSP20	143	115	19.5	66	46	M20×1.5	14	26	8	30	-	-	M5×0.8	7	40	30	37.5	1/8"	10	33.5
RMSF20	217	185	29.5	90		M22×1.5	16	29	7		8	2.5	M5×0.8	8.5	32	32	76.5		15	
RMS25	137	111	15	70	60	M26×1.5	13	32	8	36	-	-	M5×0.8	7.5	50	30	30.5	1/8"	7.5	39.5
RMSF25	238	206	37.5	90		M22×1.5	16	29	7		10	3	M6×1.0	10	36	36	85		20	
RMS32	156	124	16	80	70	M26×1.5	16	32	8	46	-	-	M6×1.0	8	50	40	37	1/8"	8	49.5
RMSP32	165	133	20.5	80		M26×1.5		32	8		36	10		3.5			12.5		48	
RMSF32	270	238	48	110	70	M30×1.5	16	36	7	46	-	-	M6×1.0	9	60	40	45	1/4"	11	49.5
RMS40	182	150	22	92		M32×2.0		41	10		46	12		4.5			M8×1.25		16	
RMSF40	327	295	44.5	130		M38×1.5		46	8											

List for ordering code of accessories

Accessories\Bore size	10		16		20		25		32		40	
	RMS	RMS	RMSP	RMSF	RMS	RMSP	RMSF	RMS	RMSF	RMS	RMSP	RMSF
Mounting accessories	LB	F-PB12LB	F-RMS16LB	F-RMSF16LB	F-RMS20LB	F-RMSF20LB	F-RMS25LB	F-RMSF25LB	F-RMS32LB	F-RMSF32LB	F-RMS40LB	F-RMSF40LB
	FA	F-PB12FA	F-PB12FA	F-MI12FA	F-MF20FA	F-MA20FA	F-MF32FA	F-MA20FA	F-MF32FA	F-MA40FA	F-MF40FA	-

Accessory selection

Accessories\Cylinder model	RMS	RMSP	RMSF
Mounting accessories	LB	•	•
	FA	•	•

Material of accessories

Accessories\Bore size	10		16		20		25		32		40	
	RMS	RMS	RMSP	RMSF	RMS	RMSP	RMSF	RMS	RMSF	RMS	RMSP	RMSF
Mounting accessories	LB	△	△	△	△	△	△	△	△	△	△	△
	FA	△	△	△	△	△	○	△	○	△	○	-

○—Lower carbon steel ; △—SPCC

Rodless magnetic cylinder

RMS Series

Dimensions

RMS-LB RMSF-LB

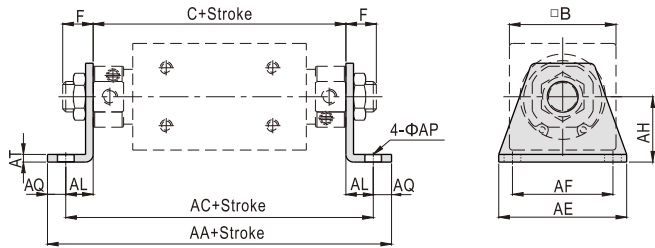

Bore size\Item	AA		AC		C		F	
	RMS	RMSP	RMS	RMSP	RMS	RMSP	RMS	RMSP
10	103	-	91	-	73	-	9	-
16	113	122	101	110	83	92	10	10
20	158	167	142	151	106	115	13	14
25	167	-	151	-	111	-	13	-
32	184	193	170	179	124	133	16	16
40	216	-	196	-	150	-	16	-

Bore size\Item	AE	AF	AH	AL	AP	AQ	AT	B
10	42	33	14	9	5.5	6	2.5	25
16	42	33	20	9	5.5	6	2.5	35
20	43	30	23	18	6.5	8	3	40
25	54	40	26	20	6.5	8	4	46
32	62	46	33	23	7	7	4	60
40	75	55	38	23	9	10	5	70

RMSF-LB

Φ16~Φ25

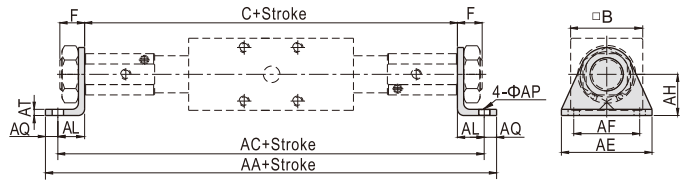

Φ32, Φ40

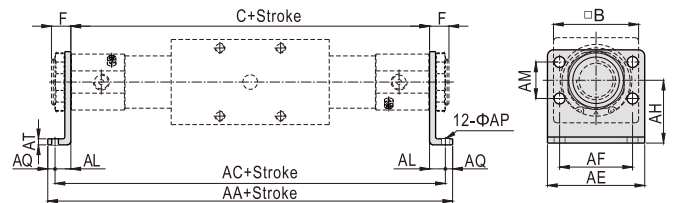

Bore size\Item	AA	AC	AE	AF	AH	AL	AM	AP	AQ	AT	B	C	F
16	221	209	44	32	20	14	-	5.5	6	2.5	35	181	12
20	235	219	54	40	23	17	-	6.5	8	3	40	185	16
25	256	240	54	40	26	17	-	6.5	8	4	46	206	16
32	280	266	66	52	33	14	28	7	7	4	60	238	16
40	353	333	80	60	38	19	30	9	10	5	70	295	16

RMS-FA RMSF-FA

Φ16~Φ32

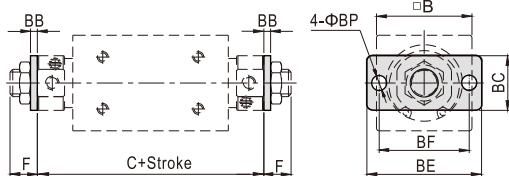

Φ40

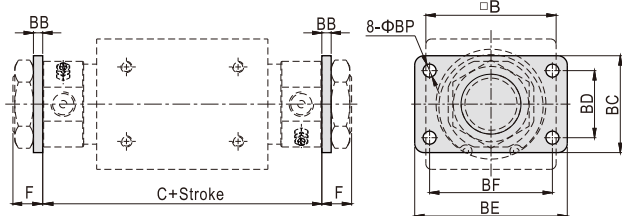

Bore size\Item	B	BB	BC	BD	BE	BF	BP	C		F	
								RMS	RMSP	RMS	RMSP
10	25	3	20	-	42	33	5.5	73	-	9	-
16	35	3	20	-	42	33	5.5	83	92	10	10
20	40	4	34	-	75	60	7	106	115	13	14
25	46	4	40	-	75	60	7	111	-	13	-
32	60	4	40	-	75	60	7	124	133	16	16
40	70	5	52	36	82	66	7	150	-	16	-

RMSF-FA

Φ16~Φ25

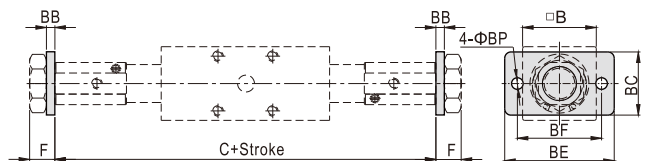

Φ32

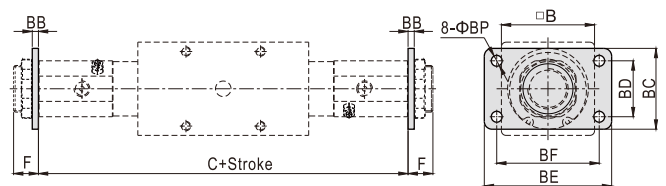

Bore size\Item	B	BB	BC	BD	BE	BF	BP	C	F
16	35	4	30	-	52	40	5.5	181	12
20	40	4	38	-	64	50	6.5	185	16
25	46	4	38	-	64	50	6.5	206	16
32	60	4	50	36	84	70	6.5	238	16