



Multi-mount cylinder—MD, MK Series

Compendium of MD/MK Series

Six bore size are available
Bore size: 6, 10, 16, 20, 25, 32

Mounted from 6 directions
Cylinder can be mounted from 6 directions, and convenient to install and use.

Front mounting

Back mounting

Left mounting

Right mounting

Bottom mounting

Up mounting

Magnetic switch slots around the cylinder body
There are magnetic switch slots around the cylinder body convenient to install inducting switch.

Mounted side by side
Multitudinous cylinder can be mounted side by side to save space.

Mounted side by side from left

Mounted side by side from right

Multi-type cylinder

MD: Multi-mount cylinder (Double acting type)	
MSD: Multi-mount cylinder (Single acting-push type)	
MTD: Multi-mount cylinder (Single acting-pull type)	
MDD: Multi-mount cylinder (Double rod type)	
MDJ: Multi-mount cylinder (Adjustable stroke type)	
MK: Multi-mount cylinder (Double acting no-rotating type)	
MSK: Multi-mount cylinder (Single acting-push no-rotating type)	
MTK: Multi-mount cylinder (Single acting-pull no-rotating type)	
MKD: Multi-mount cylinder (Double rod no-rotating type)	
MKJ: Multi-mount cylinder (Adjustable stroke no-rotating type)	

Criteria for selection: Cylinder thrust

Unit : Newton(N)

Bore size	Rod size	Acting type	Pressure area(mm ²)	Operating pressure(MPa)							
				0.1	0.2	0.3	0.4	0.5	0.6	0.7	
6	3	Single acting	Push side	28.3	-	1.5	2.9	4.3	5.7	7.2	8.6
			Pull side	21.2	-	-	0.8	1.5	2.2	2.9	3.6
		Double acting	Push side	28.3	2.8	5.7	8.5	11.3	14.1	17.0	19.8
			Pull side	21.2	2.1	4.2	6.4	8.5	10.6	12.7	14.8
10	4	Single acting	Push side	78.5	-	3.9	7.9	11.8	15.8	19.7	23.7
			Pull side	66.0	-	1.4	4.1	6.8	9.5	12.2	14.9
		Double acting	Push side	78.5	7.9	15.7	23.6	31.4	39.3	47.1	55.0
			Pull side	66.0	6.6	13.2	19.8	26.4	33.0	39.6	46.2
16	6	Single acting	Push side	201.1	-	10.1	30.2	50.3	70.4	90.5	110.6
			Pull side	172.8	-	8.7	25.9	43.2	60.5	77.8	95.1
		Double acting	Push side	201.1	20.1	40.2	60.3	80.4	100.5	120.6	140.7
			Pull side	172.8	17.3	34.6	51.8	69.1	86.4	103.7	121.0
20	8	Single acting	Push side	314.2	-	15.7	47.1	78.6	110.0	141.4	172.8
			Pull side	263.9	-	13.2	39.6	66.0	92.3	118.7	145.1
		Double acting	Push side	314.2	31.4	62.8	94.2	125.7	157.1	188.5	219.9
			Pull side	263.9	26.4	52.8	79.2	105.6	131.9	158.3	184.7
25	10	Single acting	Push side	490.9	-	24.7	73.8	122.8	179.1	221.0	270.1
			Pull side	412.3	-	20.7	61.9	103.1	144.4	185.6	226.8
		Double acting	Push side	490.9	49.1	98.2	147.3	196.3	245.4	294.5	343.6
			Pull side	412.3	41.2	82.5	123.7	164.9	206.2	247.4	288.6
32	12	Single acting	Push side	804.2	-	40.2	120.7	201.1	281.5	361.9	442.4
			Pull side	691.2	-	34.7	103.8	173.0	242.1	311.2	380.3
		Double acting	Push side	804.2	80.4	160.8	241.3	321.7	402.1	482.5	563.0
			Pull side	691.2	69.1	138.2	207.3	276.5	345.6	414.7	483.8

Installation and application



1. When load changes in the work, the cylinder with abundant output capacity shall be selected.
2. Relative cylinder with high temperature resistance or corrosion resistance shall be chosen under the condition of high temperature or corrosion;
3. Necessary protection measure shall be taken in the environment with higher humidity, much dust or water drops, oil dust and welding dregs.
4. Dirty substances in the pipe must be cleared away before cylinder is connected with pipeline to prevent the entrance of particles into the cylinder.
5. The medium used by cylinder shall be filtered to 40μm or below.
6. As both of the front cover and piston of the cylinder are short, typically too large stroke can not be selected.
7. Anti-freezing measure shall be adopted under low temperature environment to prevent moisture freezing.
8. The cylinder shall avoid the influence of side load in operation maintain the normal work of cylinder and extend the service life.
9. If the cylinder is dismantled and stored for a long time, pay attention to conduct anti-rust treatment to the surface. Anti-dust caps shall be added in air inlet and outlet ports.



Multi-mount cylinder

MD Series



Specification

Bore size(mm)		6	10	16	20	25	32
Acting type	MD/MDD/MDJ	Double acting					
	MSD/MTD	Single acting					
Fluid		Air(to be filtered by 40μm filter element)					
Operating pressure	Double acting	0.15~1.0MPa(22~145psi)					
	Single acting	0.2~1.0MPa(28~145psi)					
Proof pressure		1.5MPa(215psi)					
Temperature °C		-20~70					
Speed range mm/s		Double acting : 30~500			Single acting : 50~500		
Stroke tolerance		+1,0 0					
Cushion type		Bumper					
Port size [Note]		M5×0.8					1/8"

[Note1] PT thread, G thread are available.
Add) Refer to P365 for detail of sensor switch.

Symbol

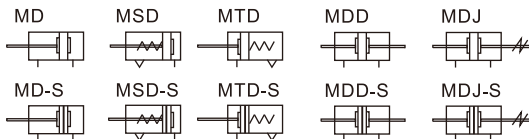

Stroke

Bore size (mm)		Standard stroke (mm)						Max.std stroke		
		5	10	15	20	25	30		35	
6	Double acting	5	10	15	20	25	30	35	35	
	Single acting	5	10	15	20				20	
10	Double acting	5	10	15	20	25	30	35	35	
	Single acting	5	10	15	20				20	
16	Double acting	5	10	15	20	25	30	40	50	
	Single acting	5	10	15	20				20	
20	Double acting	5	10	15	20	25	30	40	50	60
	Single acting	5	10	15	20				20	
25	Double acting	5	10	15	20	25	30	40	50	60
	Single acting	5	10	15	20				20	
32	Double acting	5	10	15	20	25	30	40	50	60
	Single acting	5	10	15	20				20	

Note) 1. Please contact the company for other special strokes.
2. The dimensions of non-std stroke cylinder has the same dimensions as the next longer stroke std. stroke cylinder. e.g. 23mm stroke cylinder has the same dimensions of 25 std. stroke cylinder.

Product feature

1. Manufactured by our enterprise.
2. There are several ways to fix the cylinder and it is convenient to install and use.
3. Several cylinders can be assembled together to effectively save the installation space.
4. The guide precision of piston rod is high and no additional lubricant is needed.
5. Cylinders of various specifications are optional.
6. The seal material with high temperature resistance is adopted, operating temperature range is 0~150°C.(Option).

Ordering code

MD 32 × 30 S □

MDD 32 × 30 S □

MDJ 32 × 30 -30 S □

① ② ③ ④ ⑤ ⑥

① Model	② Bore size	③ Stroke	④ Adjustable stroke	⑤ Magnet	⑥ Thread type [Note1]
MD: Multi-mount cylinder(Double acting type)	6 10 16 20 25 32	Refer to stroke table for details	No this code	Blank: Without magnet S: With magnet	Blank: PT G : G
MSD: Multi-mount cylinder(Single acting-push type)					
MTD: Multi-mount cylinder(Single acting-pull type)					
MDD: Multi-mount cylinder(Double rod type)					
MDJ: Multi-mount cylinder(Adjustable stroke type)					

[Note1] Standard thread is blank here.

Multi-mount cylinder

MD Series

Inner structure and material of major parts

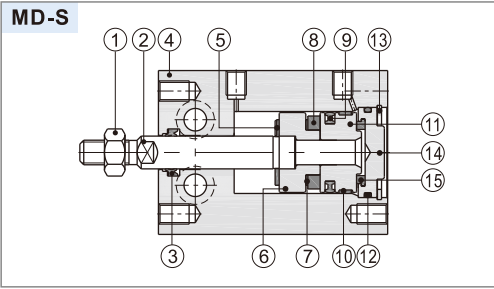

NO.	Item	Material	NO.	Item	Material
1	Rod nut	Carbon steel/Stainless steel	9	Piston seal	NBR
2	Piston rod	Stainless steel/S45C	10	Wear ring	Wear resistant material
3	Rod packing	NBR	11	Piston	Aluminum alloy
4	Body	Aluminum alloy	12	O-ring	NBR
5	Bumper	TPU	13	C-clip	Spring steel
6	Magnet holder	Aluminum alloy	14	Back cover	Aluminum alloy
7	Magnet washer	NBR	15	Bumper	TPU
8	Magnet	Sintered metal(Neodymium-iron-boron)			

Dimensions

MD

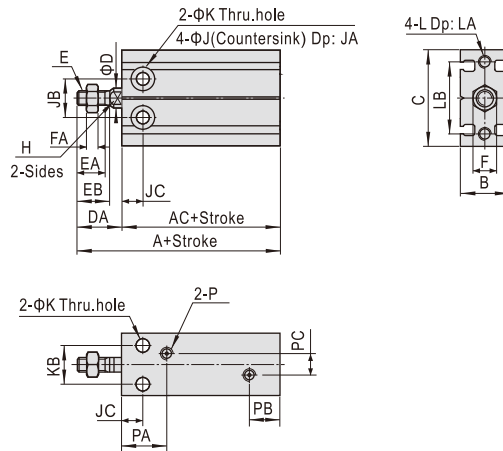

Bore size\Item	Without magnet		With magnet		B	C	D	DA	E	EA	EB	F	FA	H	J	JA	JB	JC	K	KB	L	LA	LB	P	PA	PB	PC
	A	AC	A	AC																							
6	46	33	46	33	16.5	22	3	13	M3×0.5	7	8	5.5	2.5	-	6	5	10	7	3.3	7	M3×0.5	5	17	M5×0.8	14	10	-
10	52	36	52	36	16.5	24	4	16	M4×0.7	10	11	7	2	-	6	5.5	11	7	3.3	9	M3×0.5	5	18	M5×0.8	15.5	10	-
16	46	30	56	40	20	32	6	16	M5×0.8	11	12.5	8	4	5	7.5	6.5	14	7	4.5	12	M4×0.7	5	25	M5×0.8	14.5	10	3
20	55	36	65	46	26	40	8	19	M6×1.0	12	14	10	5	6	9.5	8	16	9	5.5	16	M5×0.8	7.5	30	M5×0.8	19.3	9.5	9
25	63	40	73	50	32	50	10	23	M8×1.25	15.5	18	12	6	8	9.5	9	20	10	5.5	20	M5×0.8	8	38	M5×0.8	20.5	8.5	12
32	69	42	79	52	40	62	12	27	M10×1.25	19.5	22	17	6	10	11	11.5	24	11	6.5	24	M6×1.0	9	48	1/8"	22	12.5	13

MSD

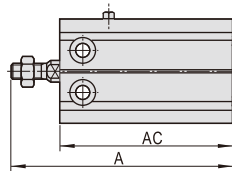

MTD

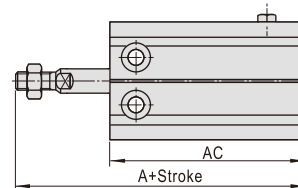

Item	A(Without magnet)				A(With magnet)				AC(Without magnet)				AC(With magnet)			
	5St	10St	15St	20St	5St	10St	15St	20St	5St	10St	15St	20St	5St	10St	15St	20St
6	56	61	71	76	56	61	71	76	43	48	58	63	43	48	58	63
10	62	67	77	82	62	67	77	82	46	51	61	66	46	51	61	66
16	61	66	81	86	71	76	91	96	45	50	65	70	55	60	75	80
20	70	75	90	95	80	85	100	105	51	56	71	76	61	66	81	86
25	78	83	98	103	88	93	108	113	55	60	75	80	65	70	85	90
32	84	89	104	109	94	99	114	119	57	62	77	82	67	72	87	92

Remark) The unmarked dimension is the same as MD standard type.

MD Series

MDD

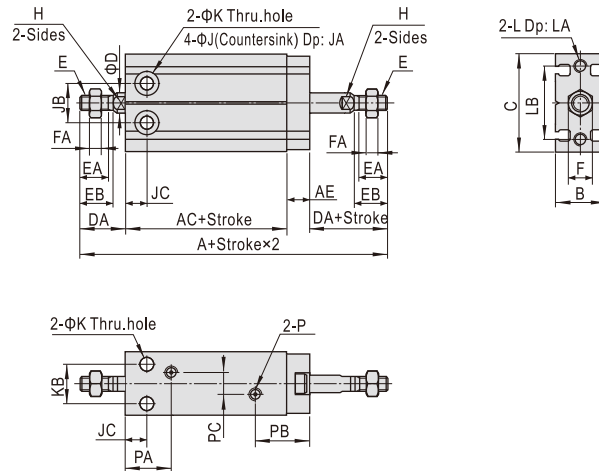

Bore size\Item	Without magnet		With magnet		AE	B	C	D	DA	E	EA	EB	F	FA	H	J	JA	JB	JC	K	KB	L	LA	LB	P	PA	PB	PC
	A	AC	A	AC																								
6	70	38	70	38	6	16.5	22	3	13	M3×0.5	7	8	5.5	2.5	-	6	5	10	7	3.3	7	M3×0.5	5	17	M5×0.8	14	16	-
10	74	36	74	36	6	16.5	24	4	16	M4×0.7	10	11	7	2	-	6	5.5	11	7	3.3	9	M3×0.5	5	18	M5×0.8	15.5	16	-
16	69.5	30	79.5	40	7.5	20	32	6	16	M5×0.8	11	12.5	8	4	5	7.5	6.5	14	7	4.5	12	M4×0.7	5	25	M5×0.8	14.5	17.5	3
20	83	36	93	46	9	26	40	8	19	M6×1.0	12	14	10	5	6	9.5	8	16	9	5.5	16	M5×0.8	7.5	30	M5×0.8	19.3	18.5	9
25	95	40	105	50	9	32	50	10	23	M8×1.25	15.5	18	12	6	8	9.5	9	20	10	5.5	20	M5×0.8	8	38	M5×0.8	20.5	17.5	12
32	106	42	116	52	10	40	62	12	27	M10×1.25	19.5	22	17	6	10	11	11.5	24	11	6.5	24	M6×1.0	9	48	1/8"	22	22.5	13

MDJ

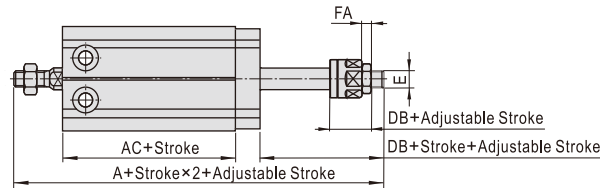

Bore size\Item	A(Without magnet)	A(With magnet)	AC(Without magnet)	AC(With magnet)	DB	E	FA
6	70	70	38	38	13	M3×0.5	2.5
10	73	73	36	36	15	M4×0.7	2
16	70.5	80.5	30	40	17	M5×0.8	4
20	85	95	36	46	21	M6×1.0	5
25	97	107	40	50	25	M8×1.25	6
32	106	116	42	52	27	M10×1.25	6

Remark) The unmarked dimension is the same as MD standard type.