

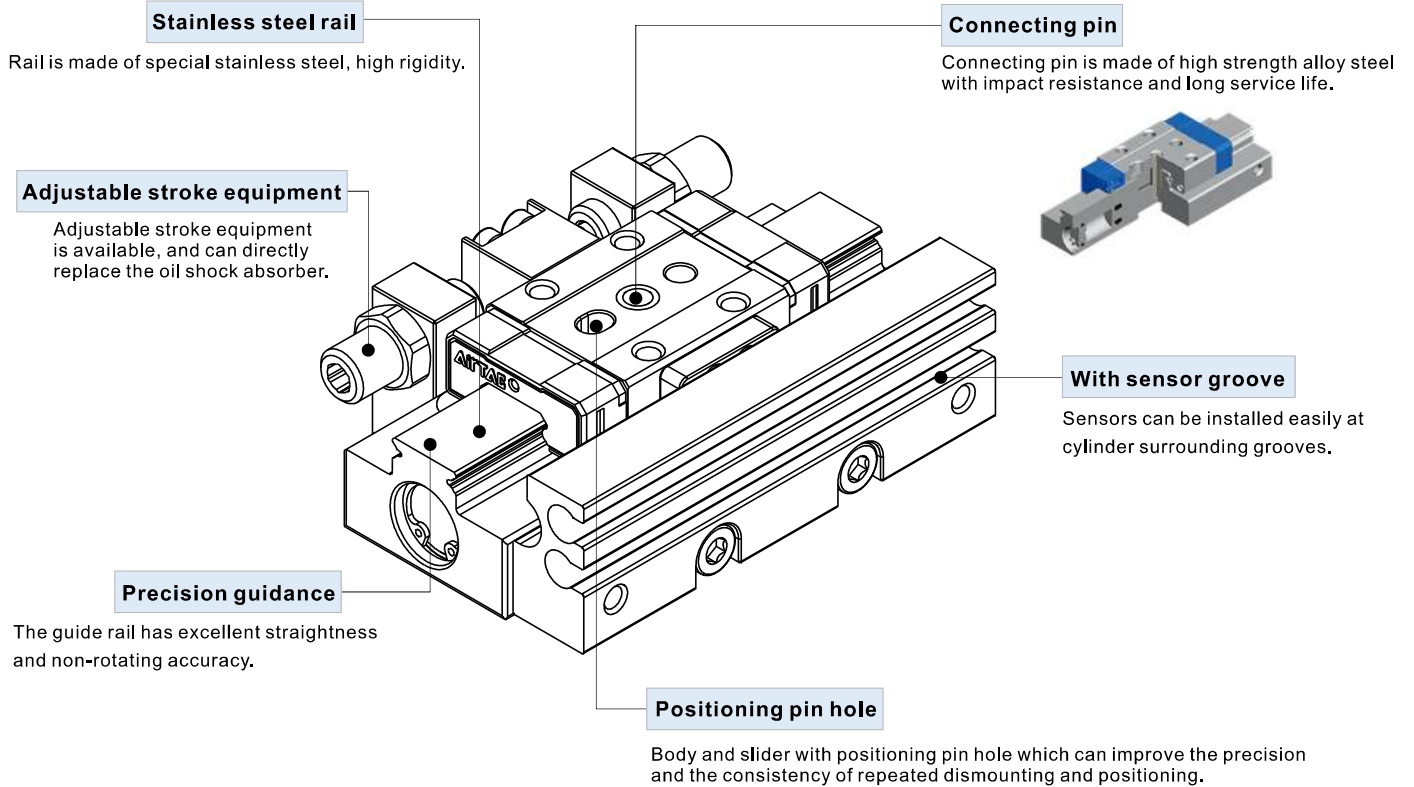

Compendium of HGS Series



Installation and application



1. Dirty substances in the pipe must be eliminated before cylinder is connected with pipeline to prevent the entrance of impurities into the cylinder.
2. The medium used by cylinder should be filtered to 40 μ m or below.
3. Anti-freezing measure shall be adopted under low temperature environment to prevent moisture freezing.
4. If the cylinder is dismantled and stored for a long time, pay attention to conduct anti-rust treatment to the surface.
Anti-dust caps shall be added in air inlet and outlet ports.

Slide table cylinder

HGS Series

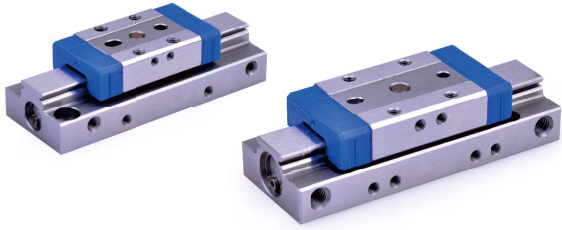

Symbol



Product feature

1. Rail is made of special stainless steel, with high rigidity, corrosion resistance.
2. Connecting pin is made of high strength alloy steel with impact resistance and long service life.
3. Adjustable stroke equipment is available, and can directly replace the oil shock absorber.
4. The guide rail has excellent straightness and no turning accuracy.
5. Sensors can be installed easily at cylinder surrounding grooves.
6. Body and slider with positioning pin hole which can improve the precision and the consistency of repeated dismounting and positioning.

Specification

Bore size(mm)	6	8	10	12
Acting type	Double acting			
Fluid	Air(to be filtered by 40μm filter element)			
Operating pressure	Φ6/8/10	36~100psi(0.25~0.7MPa)		
	Φ12	29~100psi(0.2~0.7MPa)		
Proof pressure	175psi(1.2MPa)			
Cushion type	Bumper		Bumper or shock absorber	
Temperature	-20~70°C			
Lubrication	Not required			
Speed range	50~500mm/s			
Stroke tolerance	+0.5 0			
Sensor switches	DMSH\EMSH [Note1]			
Port size	M3×0.5		M5×0.8	

Note) Refer to P362 for detail of sensor switch.

Stroke



Bore size (mm)	Standard stroke (mm)	Max.std stroke
6	5 10	10
8	5 10 15 20	20
10	5 10 15 20	20
12	5 10 15 20 25	25

[Note] Consult us for non-standard stroke.

Ordering code

HGS 10 × 15 S J

① ② ③ ④ ⑤



① Model	② Bore size	③ Stroke	④ Magnet	⑤ Stroke adjustment device
HGS: Slide table cylinder	6	5 10	Blank: Without magnet	Blank: Without stroke adjustment device
	8	5 10 15 20	S: With magnet 	J: With stroke adjustment device 
	10	5 10 15 20		[Note]
	12	5 10 15 20 25		

[Note] Stroke adjustment device of Φ10\Φ12 can be replaced by shock absorber.

Ordering code of accessories

F - HGS 10 × 15 H

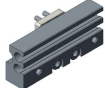
① ② ③ ④

① Model	② Bore size	③ Stroke	④ Accessories type
HGS: Slide table cylinder	6	5 10	H: Sensor fixed seat package 
	8	5 10 15 20	J: Stroke adjusting screw package 
	10	5 10 15 20	
	12	5 10 15 20 25	

Matching table

		Sensor				
Ordering code	Stroke (mm)	Stroke (mm)				
		5	10	15	20	25
Bore size	6	F-HGS6X5H	F-HGS6X10H			
	8	F-HGS8X5H	F-HGS8X10H	F-HGS8X15H	F-HGS8X20H	
	10	F-HGS10X5H	F-HGS10X10H	F-HGS10X15H	F-HGS10X20H	
	12	F-HGS12X5H		F-HGS12X15H	F-HGS12X20H	F-HGS12X25H

		Stroke adjusting screw				
Ordering code	Stroke (mm)	Stroke (mm)				
		5	10	15	20	25
Bore size	6	F-HGS6X5J	F-HGS6X10J			
	8	F-HGS8X5J	F-HGS8X10J	F-HGS8X15J		
	10	F-HGS10X5J	F-HGS10X10J	F-HGS10X15J		
	12	F-HGS10X10J				F-HGS10X15J

Slide table cylinder

HGS Series

Production weight table

Unit : g

Model	Body weight	Sensor fixed seat package weight	Stroke adjusting screw package weight		
			Single adjusting screw	Single shock absorber	Other accessories
HGS6X5	116.1	14.25	2.4	-	11.61
HGS10X5	152.3	19.05	2.4	-	11.61
HGS8X5	133.01	14.05	2.4	-	10.34
HGS8X10	167.46	18.54	2.4	-	10.34
HGS8X15	207.07	23.35	2.4	-	10.34
HGS8X20	239.37	28.16	2.4	-	10.34
HGS10X5	194.26	15.91	6.8	16	27.36
HGS10X10	248.98	19.12	6.8	16	26.2
HGS10X15	303.39	24	6.8	16	21.8
HGS10X20	352.05	28.93	6.8	16	21.8
HGS12X5	291.01	21.64	6.8	16	27.36
HGS12X10	318.12	21.64	6.8	16	26.2
HGS12X15	356.79	27.63	6.8	16	21.8
HGS12X20	445.92	33.25	6.8	16	21.8
HGS12X25	491.34	38.87	6.8	16	21.8

Example :

HGS10X15SJ=Body weight+Sensor fixed seat package weight+Single adjusting screw weightX2+Other accessories weight =303.39+24+6.8X2+21.8=362.79(g)

Inner structure and material of major parts

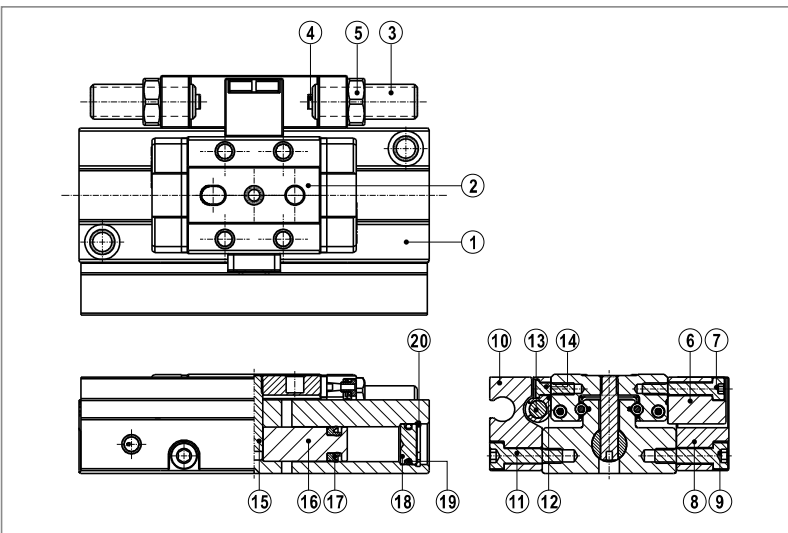

NO.	Item	Material	NO.	Item	Material
1	Body	Stainless steel	11	Hexagon socket head screws	Alloy steel
2	Slide table	Stainless steel	12	Magnet holder	Plastic
3	Adjustable screw	Stainless steel	13	Magnet	Rare earths
4	Bumper	NBR	14	Screw	Alloy steel
5	Hex nut	Stainless steel	15	Pin	Stainless steel
6	Middle stopping block	Cutting steel	16	Piston	Stainless steel
7	Hexagon socket head screws	Alloy steel	17	Piston packing	NBR
8	End stopping block	Aluminum alloy	18	End cover	Stainless steel
9	Hexagon socket head screws	Alloy steel	19	O ring	NBR
10	Sensor fixed rail	Aluminum alloy	20	C clip	Spring steel

Table precision

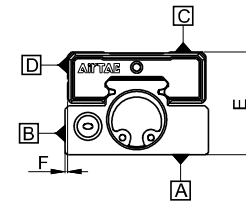

[Unit: mm]

Model		HGS6	HGS8	HGS10	HGS12
Parallelism	C surface to A surface			0.02	
	D surface to B surface			0.02	
Parallelism of walking	C surface to A surface			0.004	
	D surface to B surface			0.004	
Dimensional tolerance of E				±0.05	
Dimensional tolerance of F				±0.05	

Max. allowable load

[Unit : kg]

Model	HGS6	HGS8	HGS10	HGS12
No stroke adjustment device	0.3	0.3	0.8	1.2
With stroke adjustment device	0.2	0.5	0.8	1.2
With shock absorber	-	-	1.6	2.0

Max. allowable torque

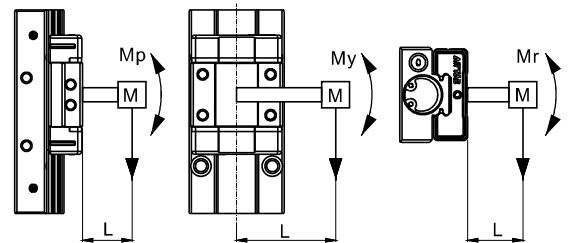

Model	Max. Allowable torque (N.m)		
	Pitch moment Mp	Yaw moment My	Roll moment Mr
HGS6X5	0.42	0.42	0.87
HGS6X10	0.42	0.42	0.87
HGS8X5	0.42	0.42	0.87
HGS8X10	0.42	0.42	0.87
HGS8X15	1.7	1.7	1.8
HGS8X20	1.7	1.7	1.8
HGS10X5	1.2	1.4	2.3
HGS10X10	1.2	1.4	2.3
HGS10X15	2.8	3.1	3.3
HGS10X20	2.8	3.1	3.3
HGS12X5	2.4	2.9	4.7
HGS12X10	2.4	2.9	4.7
HGS12X15	2.4	2.9	4.7
HGS12X20	6.5	7.7	7.3
HGS12X25	6.5	7.7	7.3

HGS Series

Table deflection

Table deflection due to pitch moment

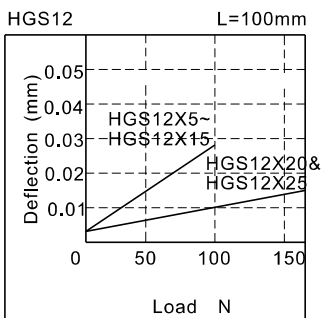
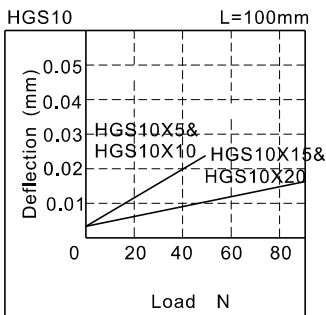
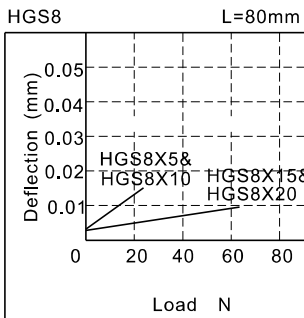
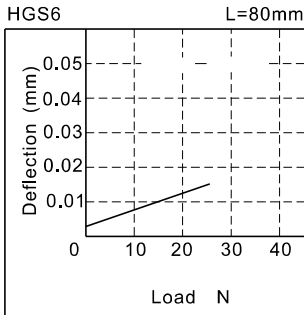
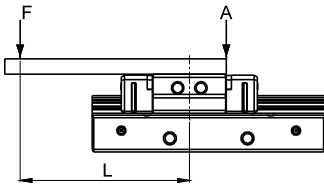

Table deflection due to yaw moment

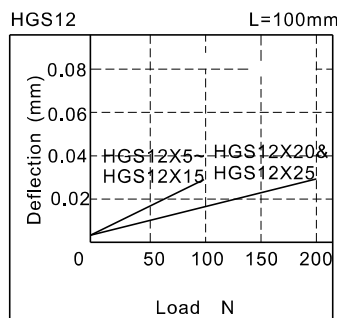
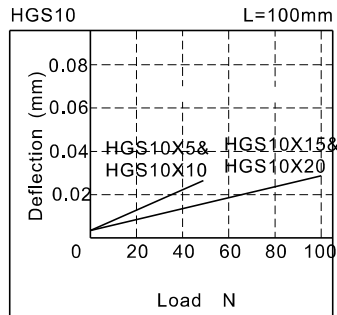
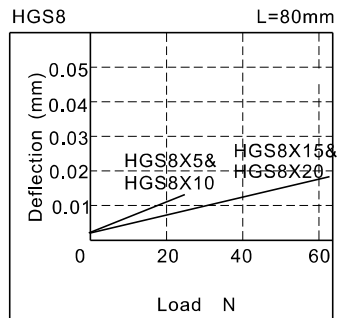
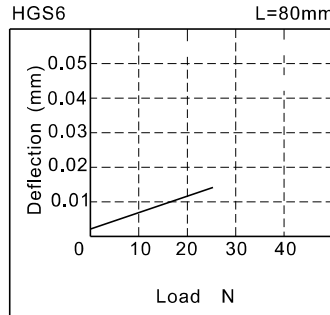
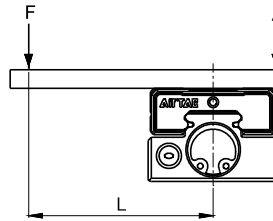
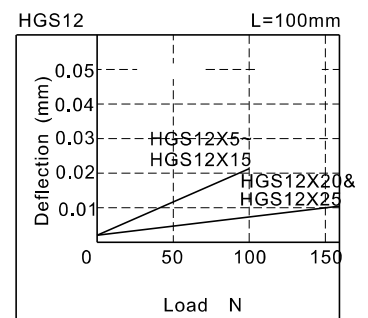
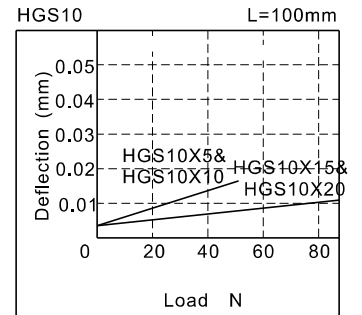
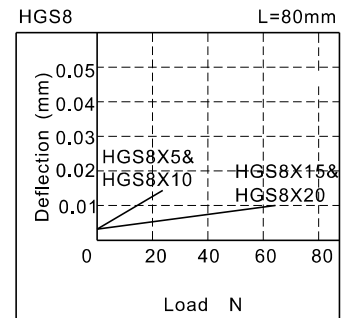
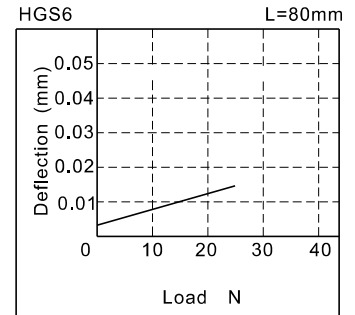
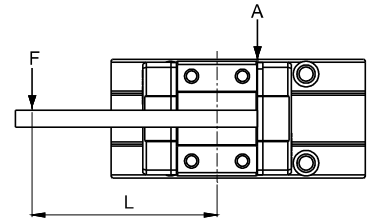

Table deflection due to roll moment



Slide table cylinder

HGS Series

Installation and application

1. Cylinder can be mounted from 4 directions
2. When mounting an compact slide cylinder, screws of appropriate length should be used and tightened properly within the maximum tightening torque.
If screws are tightened beyond designed limits, malfunction may occur. If they are tightened insufficiently, it may result in sliding or falling off from its position.

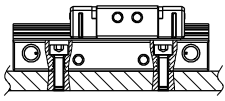

Model	Bolt used	Max. tightening torque (Nm)	Max. screw-in depth(mm)
HGS6	M3×0.5	1.1	4.3
HGS8	M3×0.5	1.1	6.3
HGS10	M3×0.5	1.1	6
HGS12	M3×0.5	1.1	4.8
HGS12	M4×0.7	2.5	4.8

Note: M3X0.5 bolt is used for HGS12X5/10.

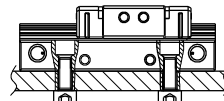

Model	Bolt used	Max. tightening torque (Nm)	Max. screw-in depth(mm)
HGS6	M4×0.7	2.5	4.3
HGS8	M4×0.7	2.5	6.3
HGS10	M4×0.7	2.5	6
HGS12	M4×0.7	2.5	4.8
HGS12	M5×0.8	5.1	4.8

Note: M4X0.7 bolt is used for HGS12X5/10.

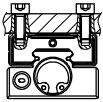

Model	Bolt used	Max. tightening torque (Nm)	Max. screw-in depth(mm)
HGS6	M3×0.5	1.1	3
HGS8	M3×0.5	1.1	3
HGS10	M3×0.5	1.1	3
HGS12	M3×0.5	1.1	4

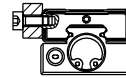

Model	Bolt used	Max. tightening torque (Nm)	Max. screw-in depth(mm)
HGS6	M2×0.4	0.26	4
HGS8	M2×0.4	0.26	4
HGS10	M3×0.5	1.1	3
HGS12	M3×0.5	1.1	4

Installation of Accessories

Locking torque shown in the following table is recommended to tighten the bolts, if bolts are tightened beyond designed limits, malfunction may occur; If they are tightened insufficiently, it may result in sliding or falling off from its position.

Stroke adjustable device

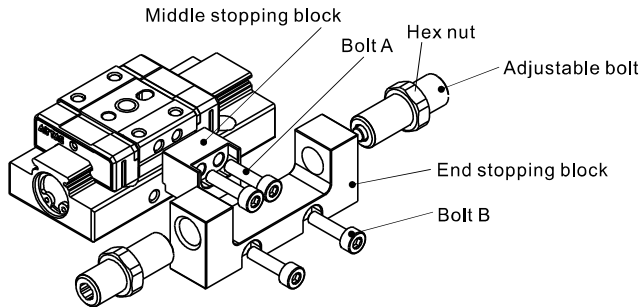

Model	Bolt A used	Max locking torque(N.m)	Bolt B used	Max locking torque(N.m)
HGS6	M2X0.4X10L	0.26	M2.5X0.45X10L	0.36
HGS8	M2X0.4X10L	0.26	M3X0.5X10L	1.1
HGS10	M3X0.5X12L	1.1	M3X0.5X12L	1.1
HGS12	M3X0.5X12L	1.1	M3X0.5X12L	1.1

Sensor Seat

Port-adapter must be assembled correctly, leaks may happen if it is missing.

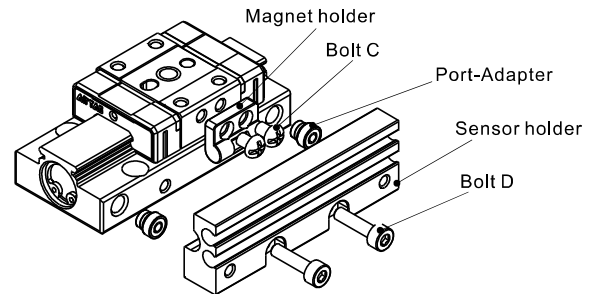

Model	Bolt C used	Max locking torque(N.m)	Bolt D used	Max locking torque(N.m)
HGS6	M2X0.4X6L	0.26	M2.5X0.45X10L	0.36
HGS8	M2X0.4X6L	0.26	M3X0.5X10L	1.1
HGS10	M3X0.5X4L	1.1	M3X0.5X10L	1.1
HGS12	M3X0.5X4L	1.1	M3X0.5X10L	1.1

Sensor seat can be installed on both sides of cylinder while stroke adjustment device can only be installed on the side with no ports.

About shock absorber

1. Shock absorbers are expendable. Promptly replace them when energy absorbing capacity decreases.
2. Never turn or adjust the screws on bottom of the shock absorber body. The screws are not for adjusting. Otherwise would cause oil leakage.
3. Follow the table for tightening torque of shock absorber to lock nuts.

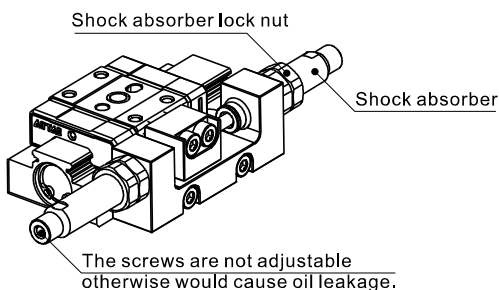

Model	Shock absorber	Tightening torque
HGS6	Without shock absorber	
HGS8		
HGS10	ACA0806-1N	1.67(N.m)
HGS12	ACA0806-1N	1.67(N.m)

Slide table cylinder

HGS Series

Dimensions(HGS6)

HGS6X5

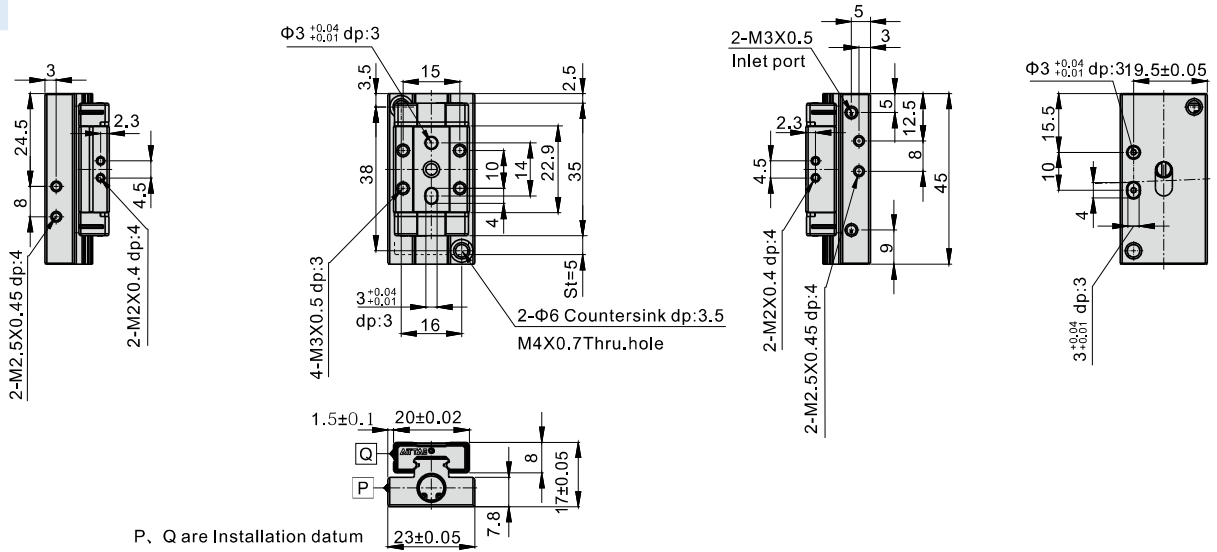

HGS6X5S

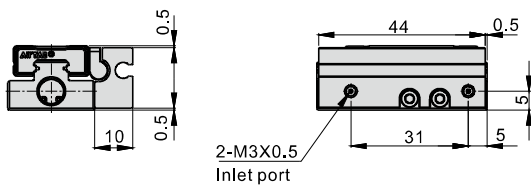

HGS6X5J Adjustable range : 5mm

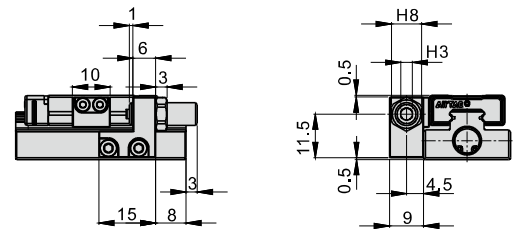

HGS6X10

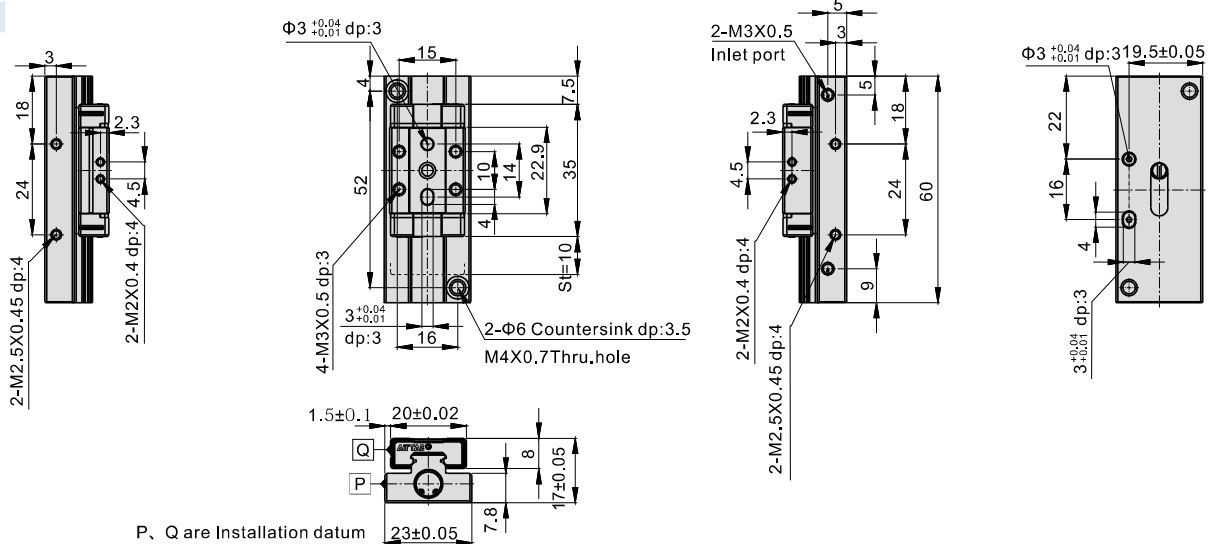

HGS6X10S

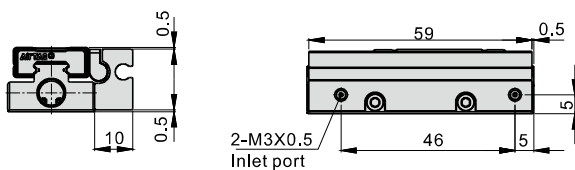

HGS6X10J Adjustable range : 5mm of each sides.

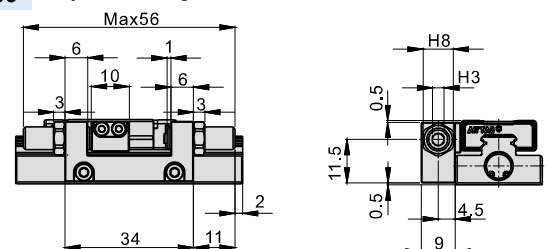

Slide table cylinder

HGS Series

HGS8X15

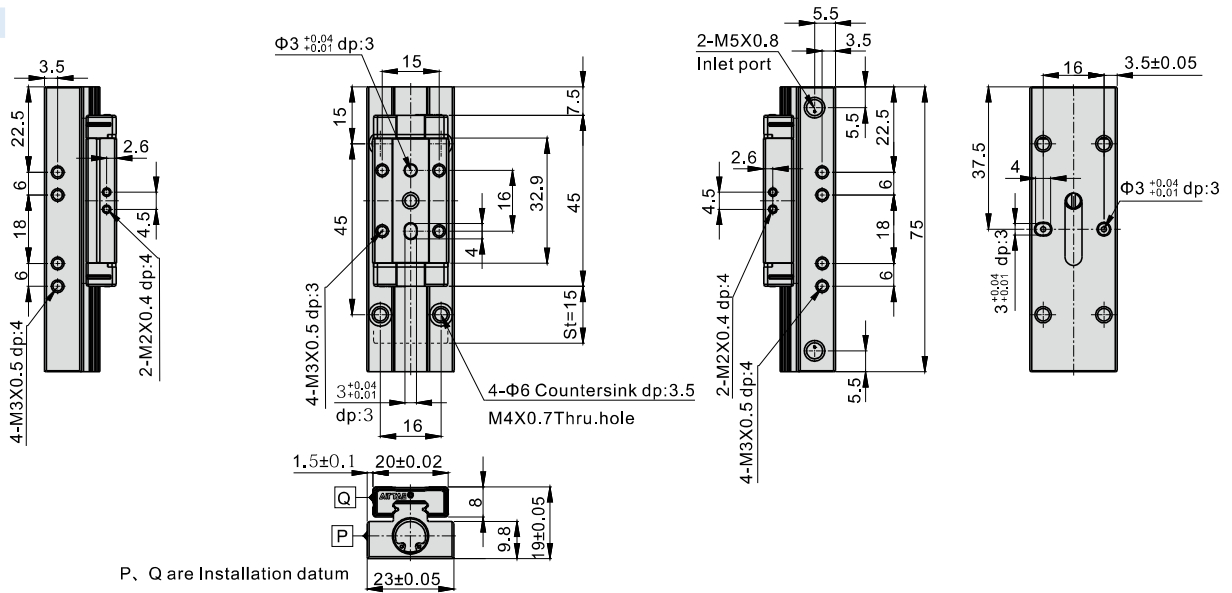

HGS8X15S

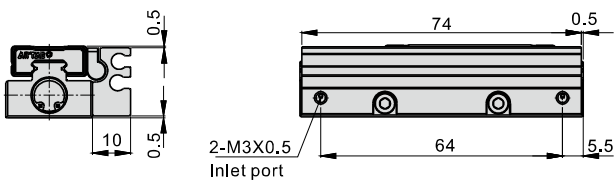

HGS8X15J Adjustable range : 5mm of each sides.

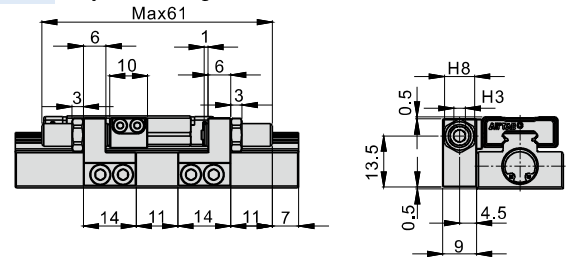

HGS8X20

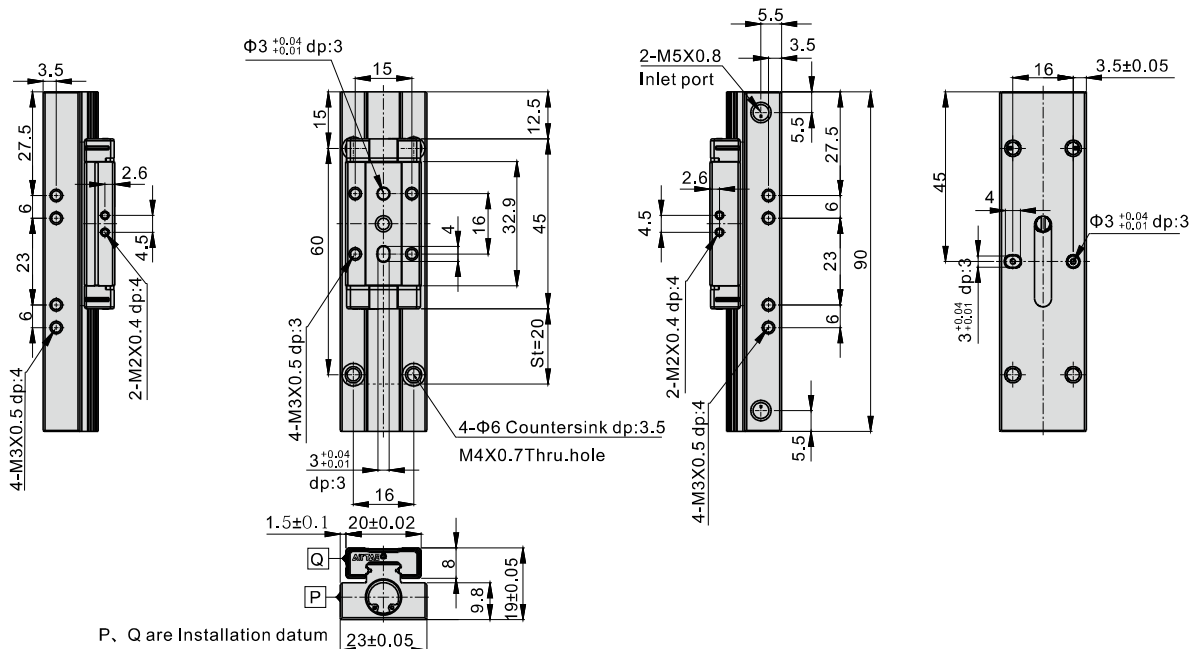

HGS8X20S

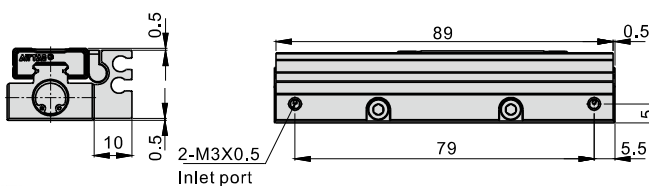

HGS8X20J Adjustable range : 5mm of each sides.

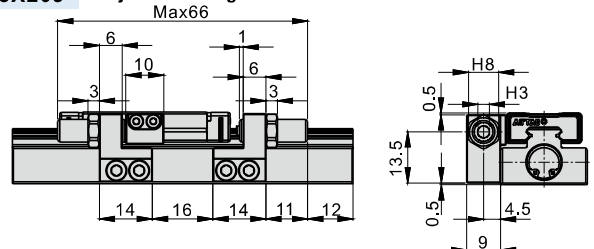

Slide table cylinder

HGS Series

HGS10X15

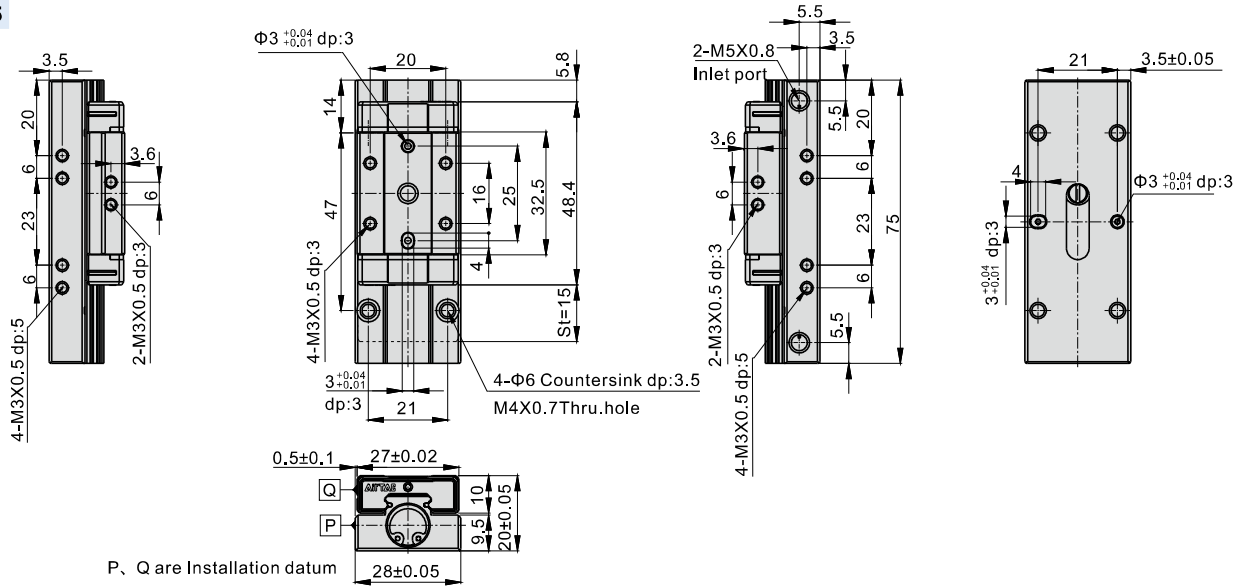

HGS10X15S

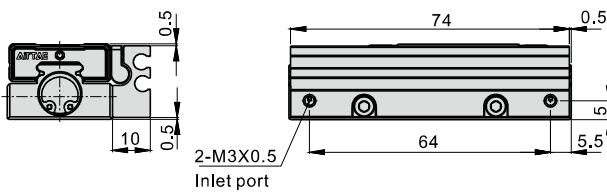

HGS10X15J Adjustable range : 5mm of each sides.

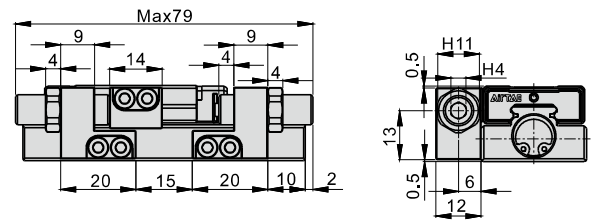

HGS10X20

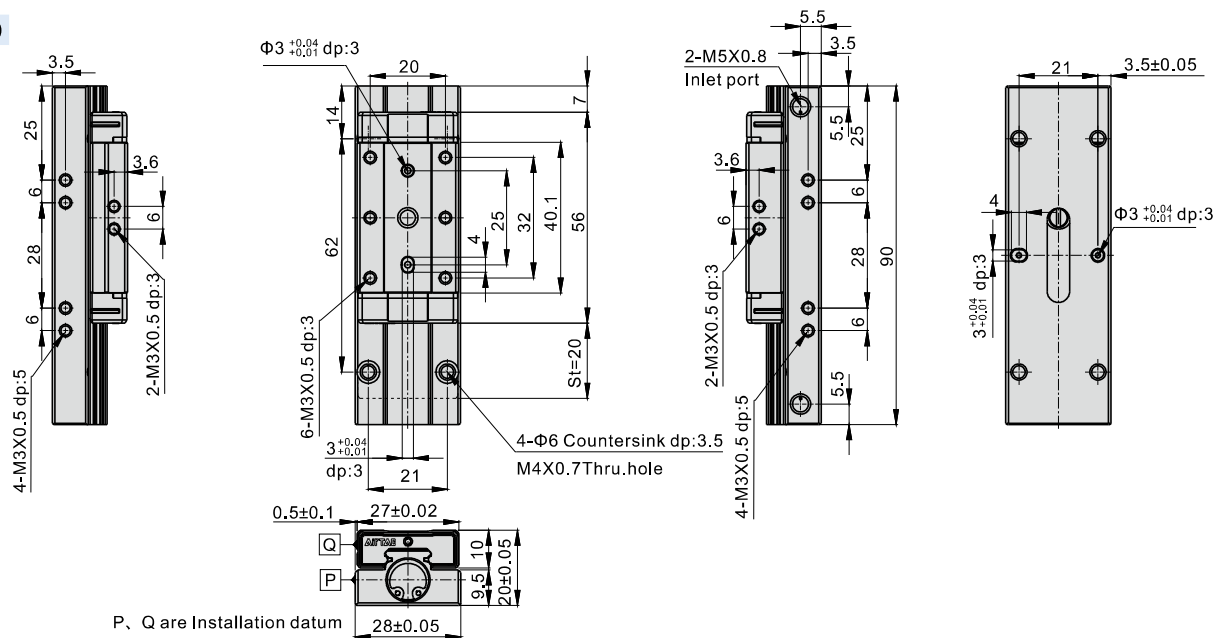

HGS10X20S

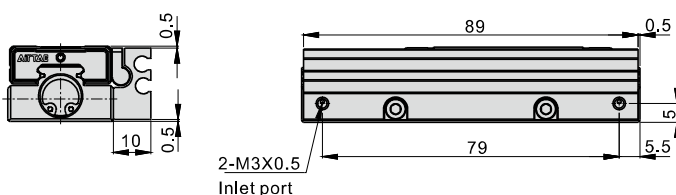

HGS10X20J Adjustable range : 5mm of each sides.

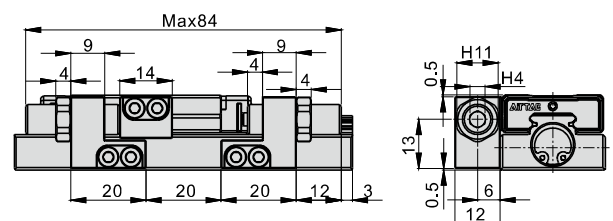

Slide table cylinder

HGS Series

Dimensions(HGS12)

HGS12X5

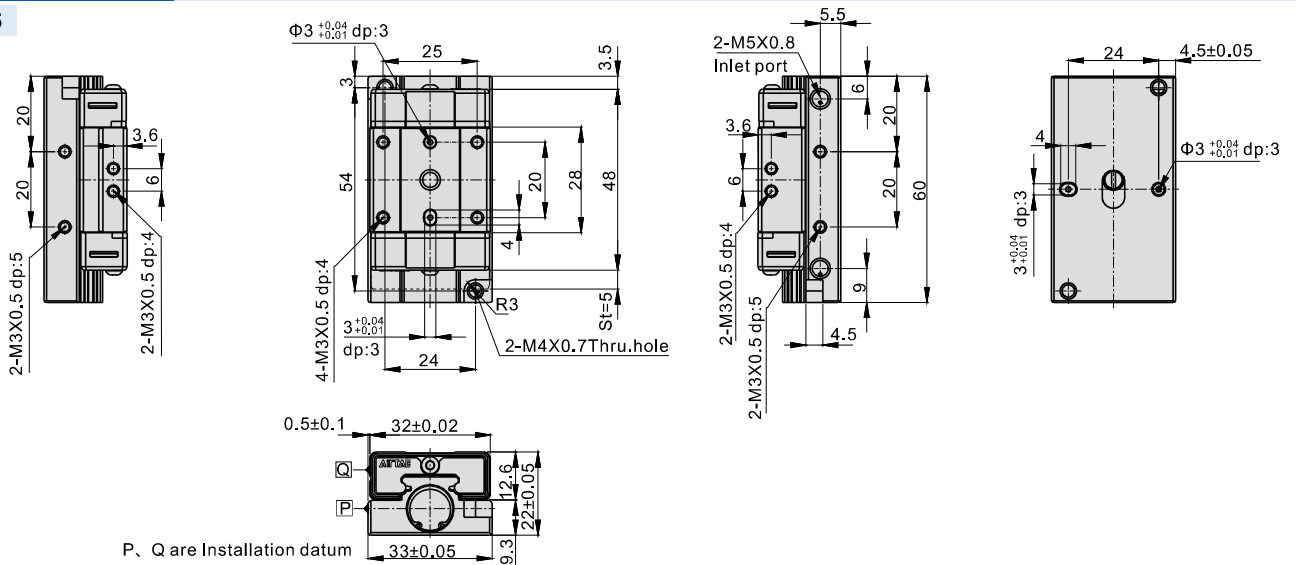

HGS12X5S

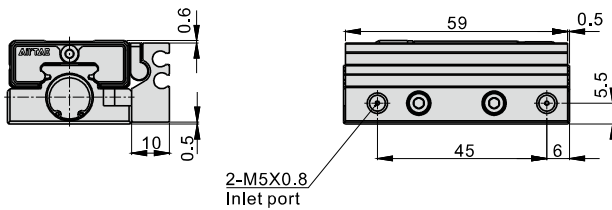

HGS12X5J Adjustable range : 5mm

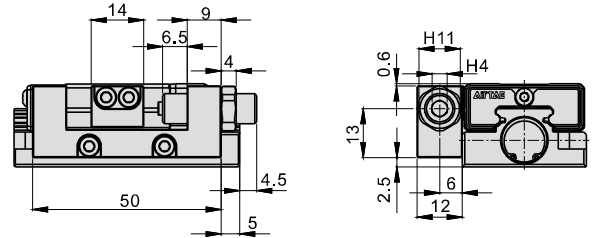

HGS12X10

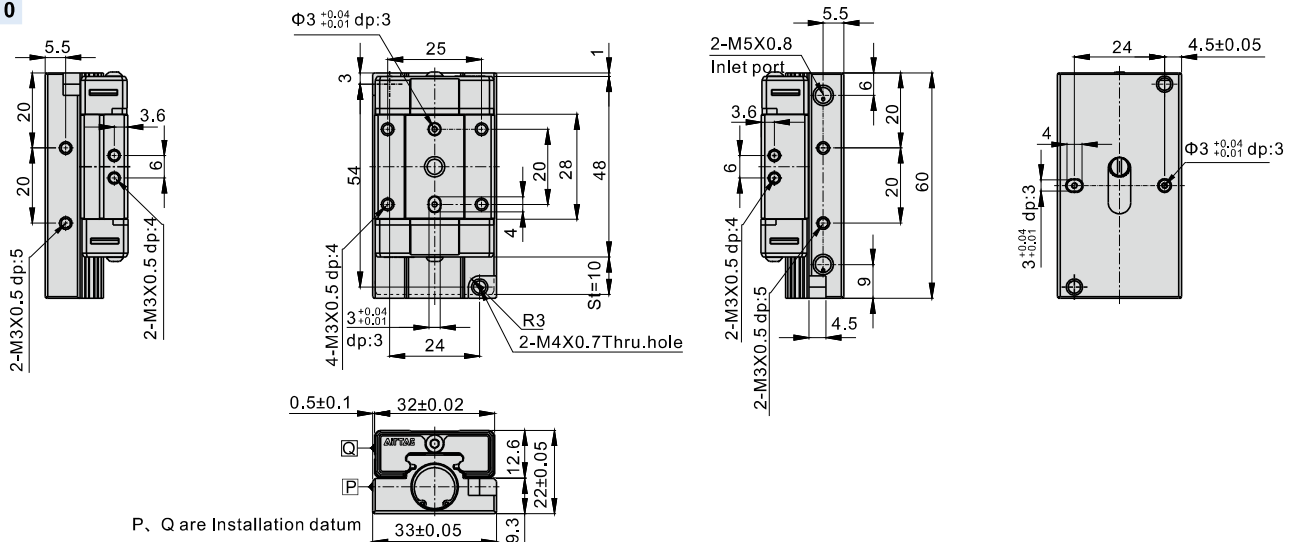

HGS12X10S

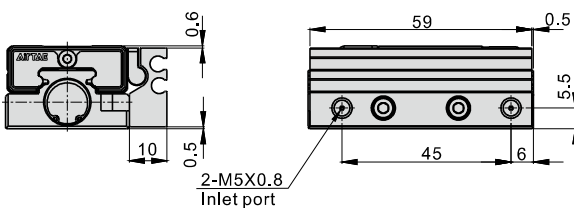

HGS12X10J Adjustable range : 5mm of each sides.

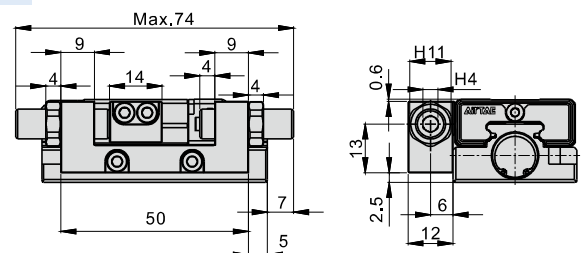

Slide table cylinder

HGS Series

HGS12X15

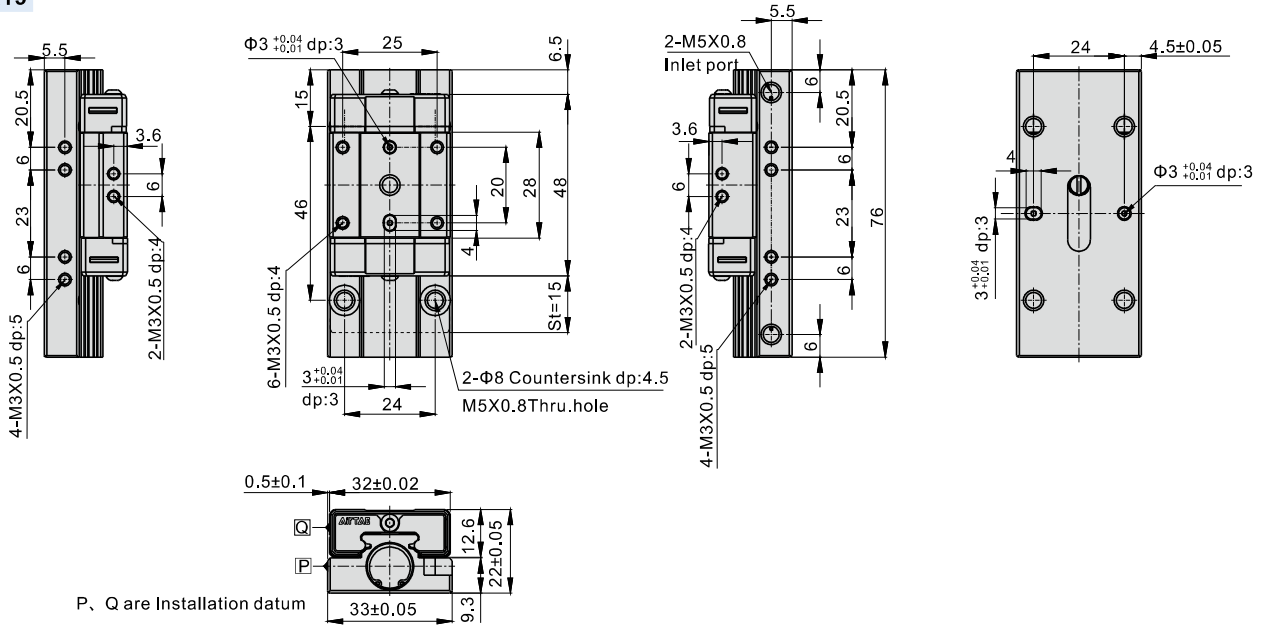

HGS12X15S

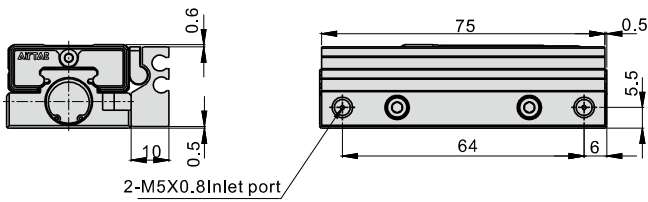

HGS12X15J Adjustable range : 5mm of each sides.

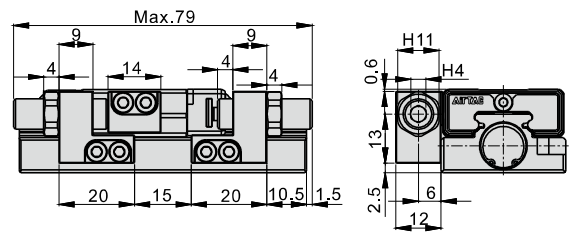

HGS12X20

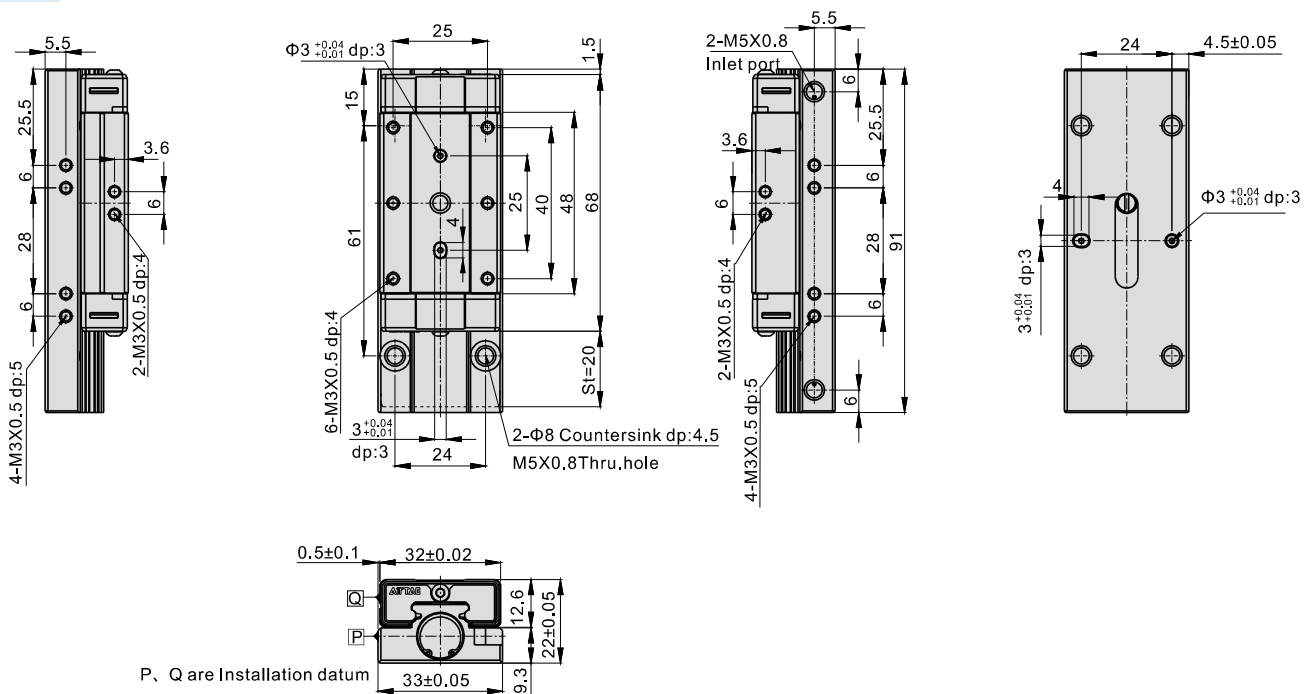

Slide table cylinder

HGS Series

HGS12X20S

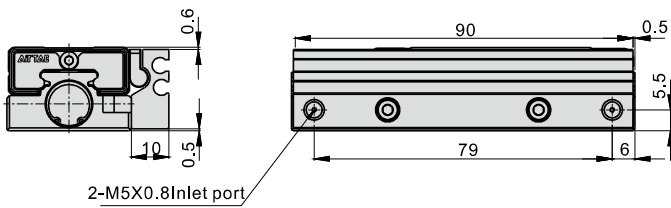

HGS12X20J Adjustable range : 5mm of each sides.

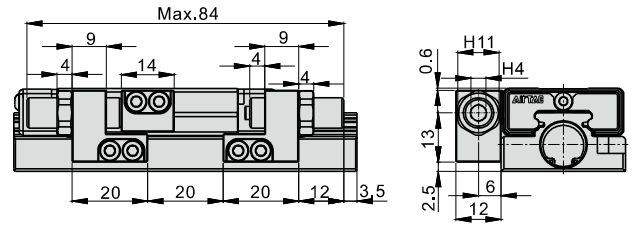

HGS12X25

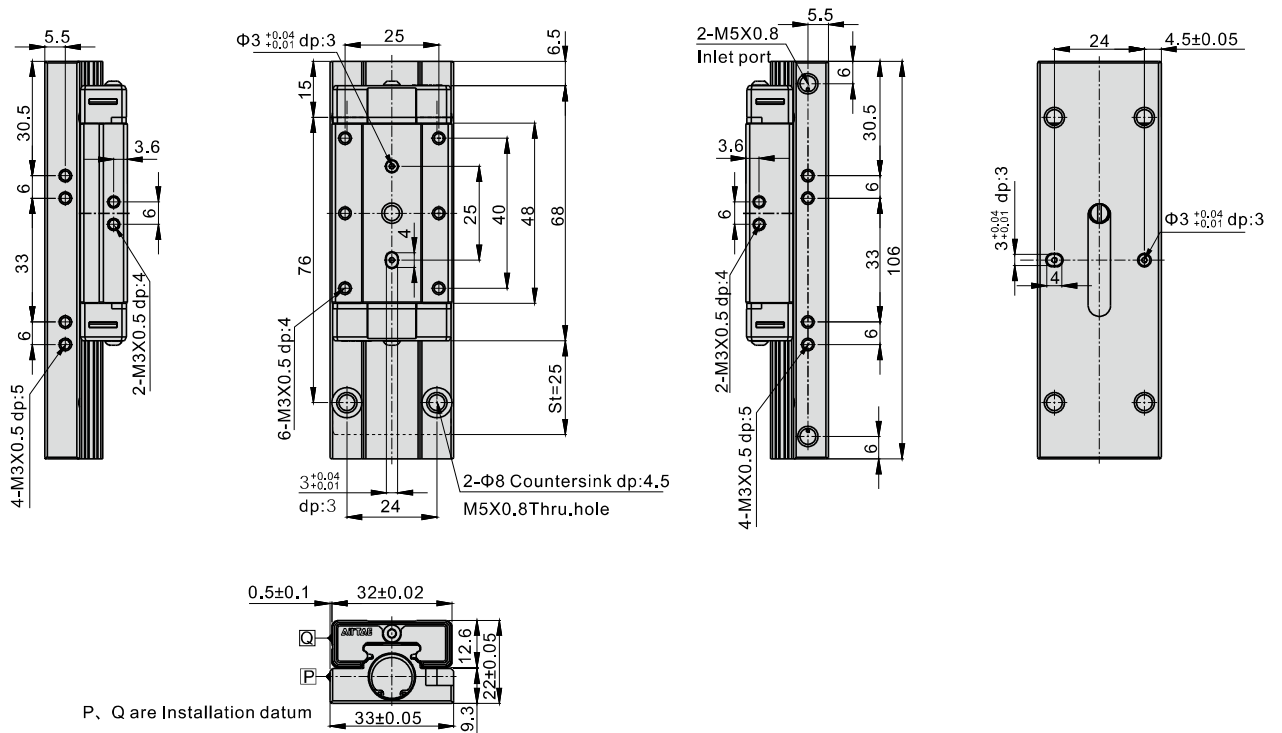

HGS12X25S

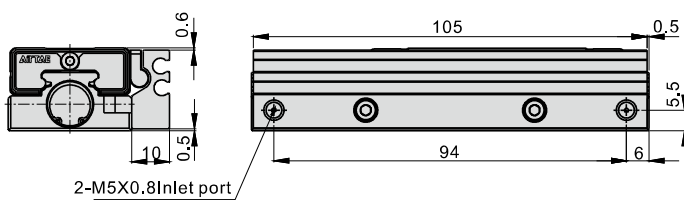

HGS12X25J

Adjustable range : 5mm of each sides.

