

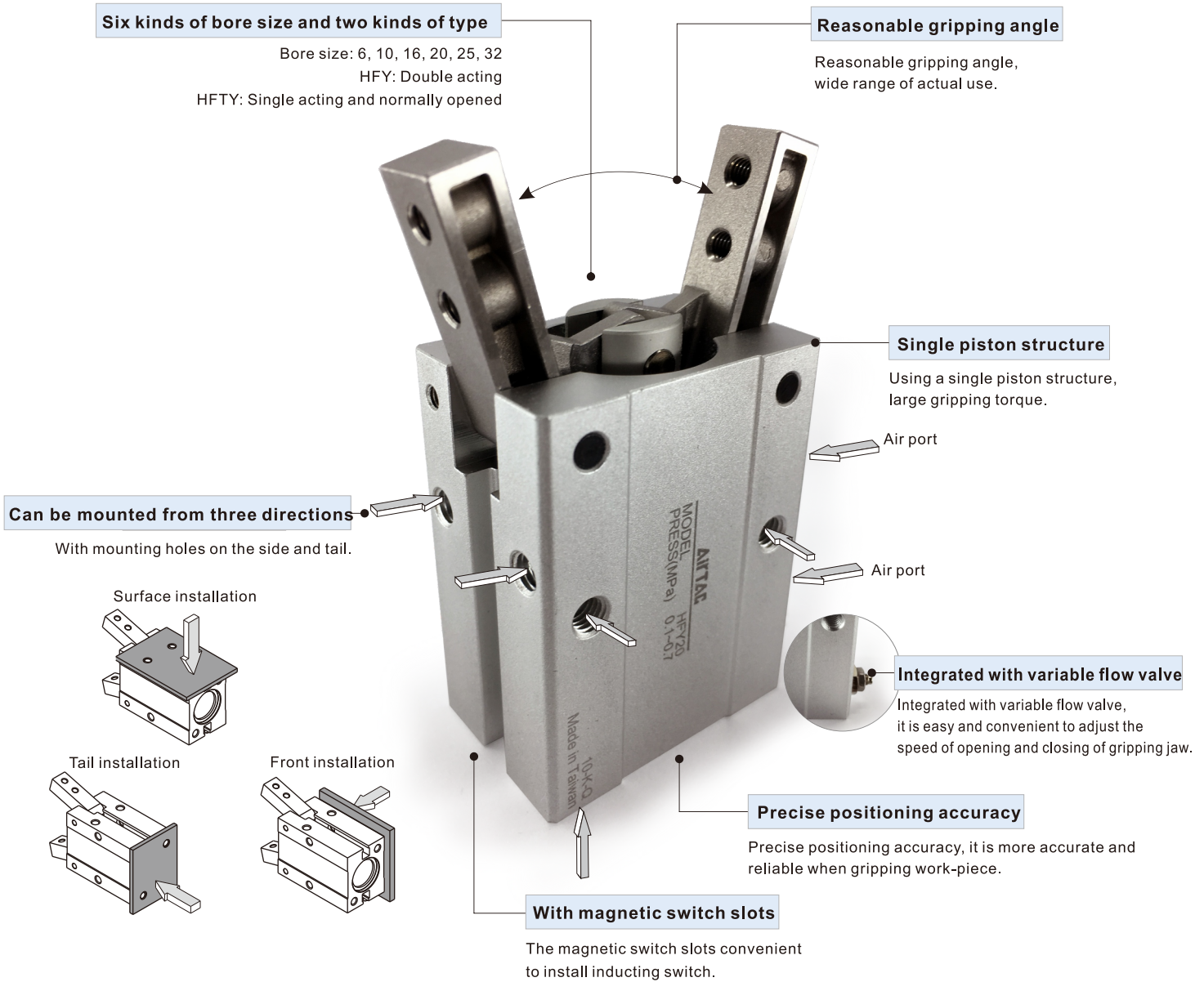

Compendium of HFY Series



Bore size (mm)		6	10	16	20	25	32	
Acting type		Double acting		Single acting				
Fluid		Air(to be filtered by 40μm filter element)						
Operating pressure	Double acting	0.2~0.7MPa(29~100psi)(2.0~7.0bar)		0.15~0.7MPa(22~100psi)(1.5~7.0bar)				
	Single acting	Φ6	0.3~0.7MPa(45~100psi)(3.0~7.0bar)					
Φ10~Φ32		0.25~0.7MPa(36~100psi)(2.5~7.0bar)						
Temperature °C		-20~70						
Lubrication		Cylinder: Not required; Gripper jaws: Lubricate grease						
Cushion type		Bumper						
Max. frequency		180(c.p.m)						
Sensor switches [Note1]		CMSH/DMSH		CMSG/DMSG				
Port size		M3×0.5			M5×0.8			

[Note1] Sensor switch should be ordered additionally, please refer to P353 for detail of sensor switch.



Air gripper(Angular style)

HFY Series



Symbol

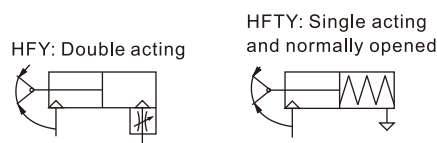

Gripping force and stroke

Acting type		Double acting(HFY)						Single acting Normally opened(HFTY)					
Bore size		6	10	16	20	25	32	6	10	16	20	25	32
Theoretical gripping torque (N·cm)	Closed	7.4×P	17.6×P	90×P	152×P	304×P	637×P	5.7×P	11.8×P	71.2×P	122.4×P	252×P	589×P
	Opened	10.6×P	29.4×P	129×P	252×P	473×P	904×P	-	-	-	-	-	-
Max. length of gripping point (L)(mm)		30	30	40	60	70	85	30	30	40	60	70	85
Opening angle (°)								30 ⁺³ ₀					
Closing angle (°)								-10 ⁰ ₋₃					

[Note] The P in the gripping torque shown in the above chart represents the actual use of air pressure.

Ordering code

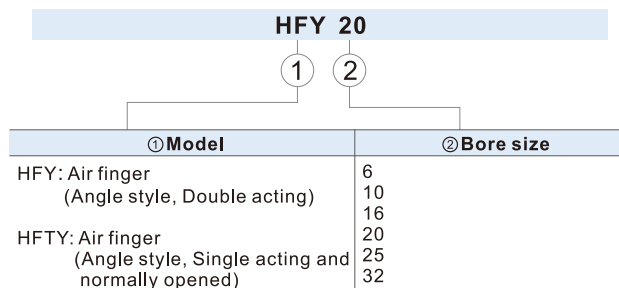

[Note] HFY series are all attached with magnet.

Inner structure and material of major parts

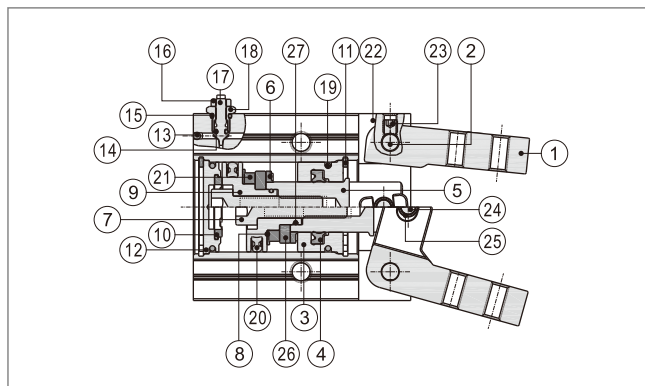

NO.	Item	Material
1	Gripping jaws	Carbon steel
2	Pin	Stainless steel
3	Front cover	Aluminum alloy
4	Rod packing	NBR
5	Piston rod	Aluminum alloy/Stainless steel
6	Bumper	TPU
7	Countersink screw	Carbon steel
8	Magnet washer	NBR
9	Piston	Aluminum alloy/Stainless steel
10	Bumper	TPU
11	C clip	Spring steel
12	Back cover	Aluminum alloy
13	Steel ball	Stainless steel
14	O-ring	NBR
15	O-ring	NBR
16	Screw cap	Carbon steel
17	Adjustable nut	Brass
18	Fixed nut	Brass
19	O-ring	NBR
20	Piston seal	NBR
21	Magnet	Sintered metal(Neodymium-iron-boron)
22	Body	Aluminum alloy
23	Countersink screw	Carbon steel
24	Pin	Stainless steel
25	Pin sheath	Stainless steel
26	Magnet fixed flake	Stainless steel
27	O-ring	NBR

Air gripper(Angular style)

HFY Series

Dimensions

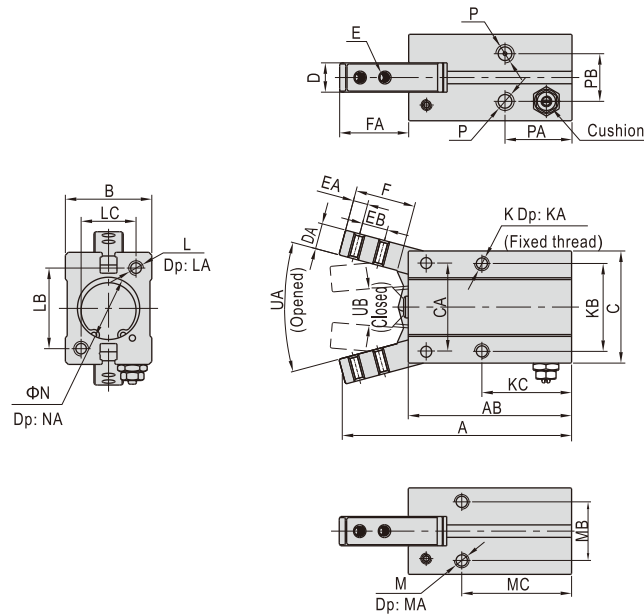

Bore size\Item	A	AB	B	C	CA	D	DA	E	EA	EB	F	FA	K	KA	KB	KC	L
6	47.5	36	10.5	20	14	4	4	M2×0.4	2.5	5	11	12	M3×0.5	Thru. thread	12	26	-
10	52.5	38.5	16.5	23	14	6.4	4	M2.5×0.45	3	5.7	12	14.5	M3×0.5	5	16	23	M3×0.5
16	62.5	44.5	23.5	30.5	24	8	7	M3×0.5	4	7	16	19	M4×0.7	7	24	24.5	M4×0.7
20	78	55	27.5	42	30	10	8	M4×0.7	5	9	20	23.5	M5×0.8	8	30	29	M5×0.8
25	92	60.5	33.5	52	36	12	10	M5×0.8	8	12	27	33	M6×1.0	10	36	30	M6×1.0
32	96.5	68	40	60	42	18	10	M6×1.0	6	14	27	29.5	M6×1.0	10	44	37.5	M6×1.0

Bore size\Item	LA	LB	LC	M	MA	MB	MC	N	NA	P	PA	PB	UA(Opened)	UB(Closed)
6	-	-	-	-	-	-	-	7 ^{+0.05} ₀	1.5	M3×0.5	19	1.5	30°	10°
10	6	18	12	M3×0.5	6	11.5	27	11 ^{+0.05} ₀	1.5	M3×0.5	19	10	30°	10°
16	8	22	15	M4×0.7	8	16	30	17 ^{+0.05} ₀	1.5	M5×0.8	18.5	13	30°	10°
20	10	32	18	M5×0.8	10	18.5	35	21 ^{+0.05} ₀	1.5	M5×0.8	22	15	30°	10°
25	12	40	22	M6×1.0	10	22	36.5	26 ^{+0.05} ₀	1.5	M5×0.8	23.5	20	30°	10°
32	12	46	26	M6×1.0	10	26	30	34 ^{+0.05} ₀	2	M5×0.8	31	24	30°	10°

How to select product

1. The selection of the gripping force

The gripping work-pieces shown below, on the impact condition of ordinary handling state, taking safety coefficient a=4, have a gripping force that is more than 10-20 times of the mass of the gripped objects.

	The work-pieces as shown in the left :		$\mu=0.2$	$\mu=0.1$
	F: Gripping force (N) μ : friction coefficient between fittings and work-pieces. m: mass of work-pieces g: acceleration of gravity (=9.8m/s ²)	The condition that the work-pieces won't drop is: $2 \times \mu F > mg$ so: $F > \frac{mg}{2 \times \mu}$ Safety coefficient is a, so F is: $F = \frac{mg}{2 \times \mu} \times a$	$F = \frac{mg}{2 \times 0.2} \times 4 = 10 \times mg$	$F = \frac{mg}{2 \times 0.1} \times 4 = 20 \times mg$
		10 times of the mass of the gripped objects	20 times of the mass of the gripped objects	

Note) If the friction coefficient $\mu > 0.2$, for safety, please also select clamping force according to the principle of 10~20 times of the mass of the clamped objects. As for large acceleration and shock, it requires for greater safety coefficient.

2. The selection of the gripping point

When the gripping force is determined, select the gripping point according to the limitation ranges shown in the below chart. If the gripping point is over the limit, the gripping jaw will be subjected to excessive moment load, and lead to short life of air gripper.

HFY Series

Double acting type closed gripping force

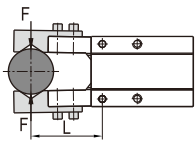

Gripping point length (mm)

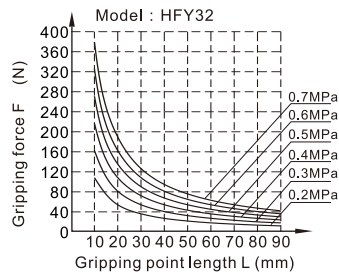
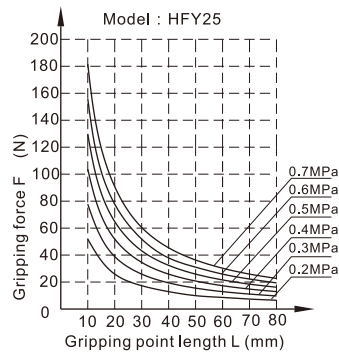
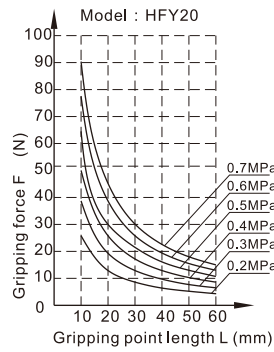
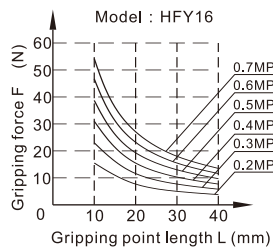
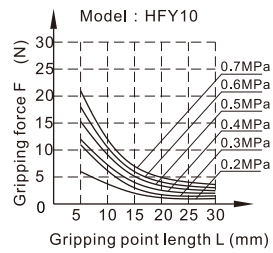
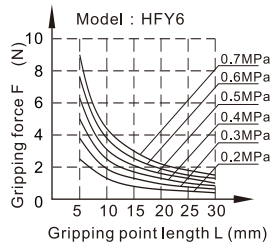

Single acting closed gripping force

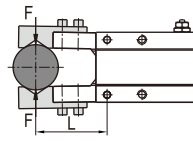

Gripping point length (mm)

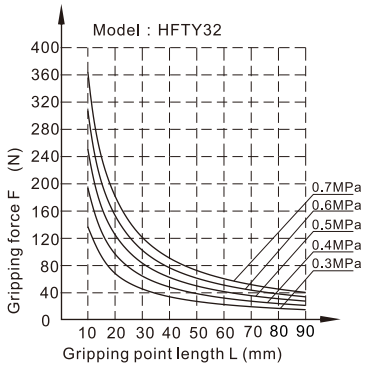
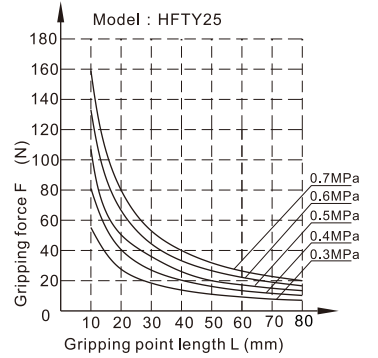
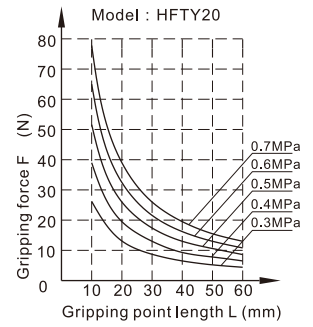
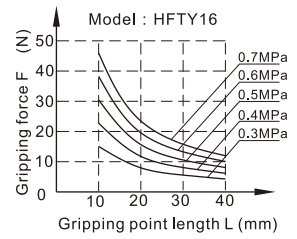
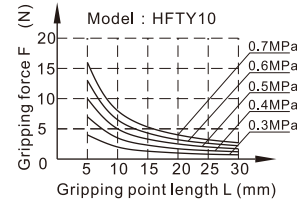
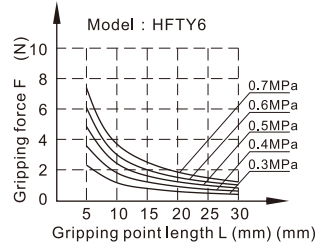

Installation and application

1. Due to the abrupt changes, the pressure is low, which will lead to the decrease of the gripping force and falling of the work-pieces. In order to avoid the harm to the human body and damage to the equipment, anti-dropping device must be equipped.
2. Don't use the air gripper under strong external force and impact force.
3. When install and fix the air gripper, avoid falling down, collision and damage.
4. When fixing the gripping jaw parts, don't twist the gripping jaw.
5. There are several kinds of installation method, and the torque of fastening screw must be within the prescribed moment range shown in the below chart. If the locking moment is too large, it will cause the dysfunctional. If the locking moment is too small, it will cause the position deviation and fall.

Tail installation type

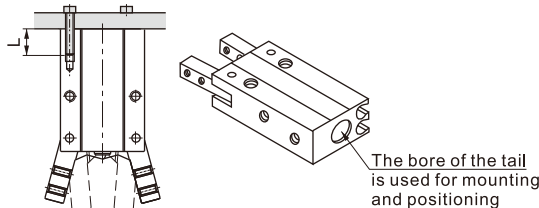

Bore size	The bolts type	Max. locking moment	Max. screwed depth	The aperture of the positioning bore	The depth of the positioning bore
6	-	-	-	Φ7mm	1.5mm
10	M3×0.5	0.88N.m	6mm	Φ11mm ^{+0.04} _{+0.01}	1.5mm
16	M4×0.7	2.1N.m	8mm	Φ17mm ^{+0.05} ₀	1.5mm
20	M5×0.8	4.3N.m	10mm	Φ21mm ^{+0.05} ₀	1.5mm
25	M6×1.0	7.3N.m	12mm	Φ26mm ^{+0.05} ₀	1.5mm
32	M6×1.0	7.3N.m	12mm	Φ34mm ^{+0.05} ₀	2.0mm

The installation of the front threaded hole

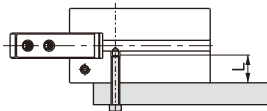

Bore size	The bolts type	Max. locking moment(Nm)	Max. screwed depth(mm)
6	M3×0.5	0.69	5
10	M3×0.5	0.69	5
16	M4×0.7	2.1	7
20	M5×0.8	4.3	8
25	M6×1.0	7.3	10
32	M6×1.0	7.3	10

The installation of the front through hole

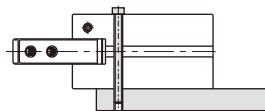

Bore size	The bolts type	Max. locking moment(Nm)	Max. screwed depth(mm)
6	M2.5×0.45	0.49	5
10	M2.5×0.45	0.49	5
16	M3×0.5	0.88	7
20	M4×0.7	2.1	8
25	M5×0.8	4.3	10
32	M5×0.8	4.3	10

Surface installation type

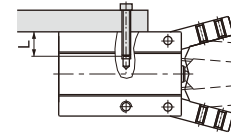

Bore size	The bolts type	Max. locking moment(Nm)	Max. screwed depth(mm)
6	-	-	-
10	M3×0.5	0.88	6
16	M4×0.7	1.6	6.5
20	M5×0.8	3.3	8
25	M6×1.0	5.9	10
32	M6×1.0	5.9	10

6. The installation method of the gripping jaw fittings
When install the gripping jaw fittings, you have to pay particular attention that you can only hold the gripping jaw by using spanner, and then lock the screws with allen wrench. Never clamp the body directly and then lock the screws, otherwise the parts will be easily damaged.

Bore size	The bolts type	Max. locking moment(Nm)
6	M2×0.4	0.15
10	M2.5×0.45	0.31
16	M3×0.5	0.59
20	M4×0.7	1.4
25	M5×0.8	2.8
32	M6×1.0	4.9

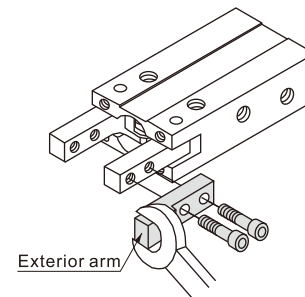

7. When gripping work-piece, the work-piece must be located in the center line of the two gripping jaws, and the two gripping jaws also need to touch the work-piece at the same time, otherwise they will be easily damaged.
8. Confirm that there is no additional external forces that are exerted on the gripping jaw. Transverse load acts on the gripping jaw, which will cause impact load and leads to the shaking and damage of gripping jaw. Equip with gaps so that the air gripper will not crash into work-pieces and accessories at the end of its trip.
9. When the work-pieces are inserted, the center line should be coaxial, no offset, in case there are external force generated on gripping jaw. When testing, it is specially required that the manual operation should be reduced, the pressure should be used to run it at a low speed, and guarantee the safety and no impact.
10. Please use the flow control valve to adjust the opening and closing speed of gripping jaw if too fast.
11. People can not enter the movement path of air gripper and articles can not be placed on the path too.
12. Before removing the air gripper, please confirm that it is out of working state, and then discharge of compressed air.